

YAMAHA T-7

Natural Sound AM/FM Stereo Tuner
10-Station Preset Tuning
Selectable Local/Auto DX Modes
Optical Balance Tuning
Optimum Tuning System/FM Muting

OWNER'S MANUAL



Thank you for purchasing the YAMAHA T-7 AM/FM stereo tuner.
This sophisticated tuner comes with a full range of features for the ultimate in audio performance. It provides exceptionally accurate music reproduction under even the most demanding reception conditions.

Please read these instructions through before operating your tuner and retain this booklet for reference so as to ensure that you will gain the maximum from your T-7 through many years of use.

CONTENTS

CAUTION: READ THIS BEFORE OPERATING YOUR T-7.....	2
CONNECTION DIAGRAM.....	3
CONNECTIONS.....	4
NAMES OF THE PARTS AND THEIR FUNCTIONS.....	5/6
RX MODE/SIGNAL QUALITY INDICATOR/ MULTIPATH INTERFERENCE.....	7
PRESET TUNING/ MEMORY BACKUP POWER SUPPLY.....	8
TROUBLESHOOTING.....	9
SPECIFICATIONS.....	10

IMPORTANT

Please record the serial number of your unit in the space below.

Model: T-7

Serial No.:

The serial number is located on the rear of the cabinet. Retain this Owner's Manual in a safe place for future reference.

Special Instructions for British Model

THE WIRES IN THE MAINS LEAD ARE COLOURED IN ACCORDANCE WITH THE FOLLOWING CODE:

Blue: NEUTRAL

Brown: LIVE

As the colours of the wires in the mains lead of this apparatus may not correspond with the coloured markings identifying the terminals in your plug, proceed as follows. The wire which is coloured BLUE must be connected to the terminal which is marked with the letter N or coloured BLACK. The wire which is coloured BROWN must be connected to the terminal which is marked with the letter L or coloured RED.

WARNING

To prevent fire or electrical shock, do not expose this tuner to rain or moisture.



**CAUTION: READ
THIS BEFORE OPERATING
YOUR T-7**

1

The T-7 is a sophisticated AM/FM stereo tuner. To ensure proper operation for the best possible sound reproduction, please read this manual carefully.

2

Choose the installation location of your T-7 carefully. Avoid placing it in direct sunlight or close to a source of heat. Also avoid locations subject to vibration and excessive dust heat, cold or moisture.

3

Do not open the cabinet as this might result in damage to the set or electrical shock. If a foreign object should get into the set, contact your dealer.

4

To prevent lightning damage, pull out the power cord and remove the antenna cable in case of an electrical storm.

5

When removing the power plug from the wall outlet, always pull directly on the plug; never yank the cord.

6

Do not use force when using the switches and knobs.

7

When moving the set be sure to first pull out the power plug and remove cords connecting to other equipment.

8

Do not attempt to clean the T-7 with chemical solvents as this might damage the finish. Use a clean, dry cloth.

9

Be sure to read the "troubleshooting" section for advice on common operating errors before concluding that your T-7 is faulty.

10

Keep this manual in a safe place for future reference.

11

If your T-7 has a voltage selector, check that it is set to your local voltage before you plug it in. If not properly set, unscrew the two switch-guard retaining screws, and reset the switch to indicate your supply voltage (110–130 V, or 220–240 V). After setting the voltage selector switch to the correct voltage, replace the switch guard and attach it with two retaining screws.

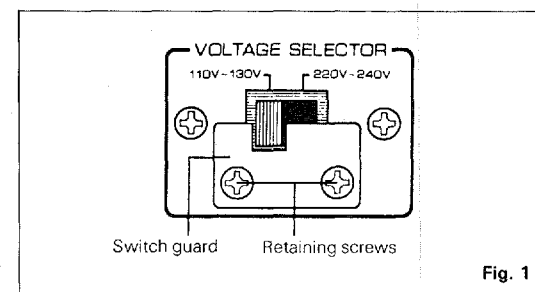
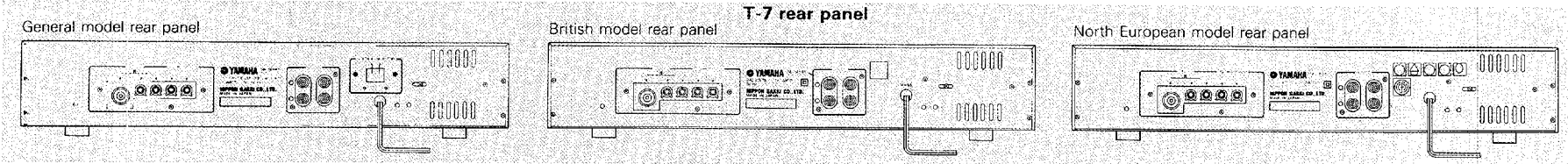
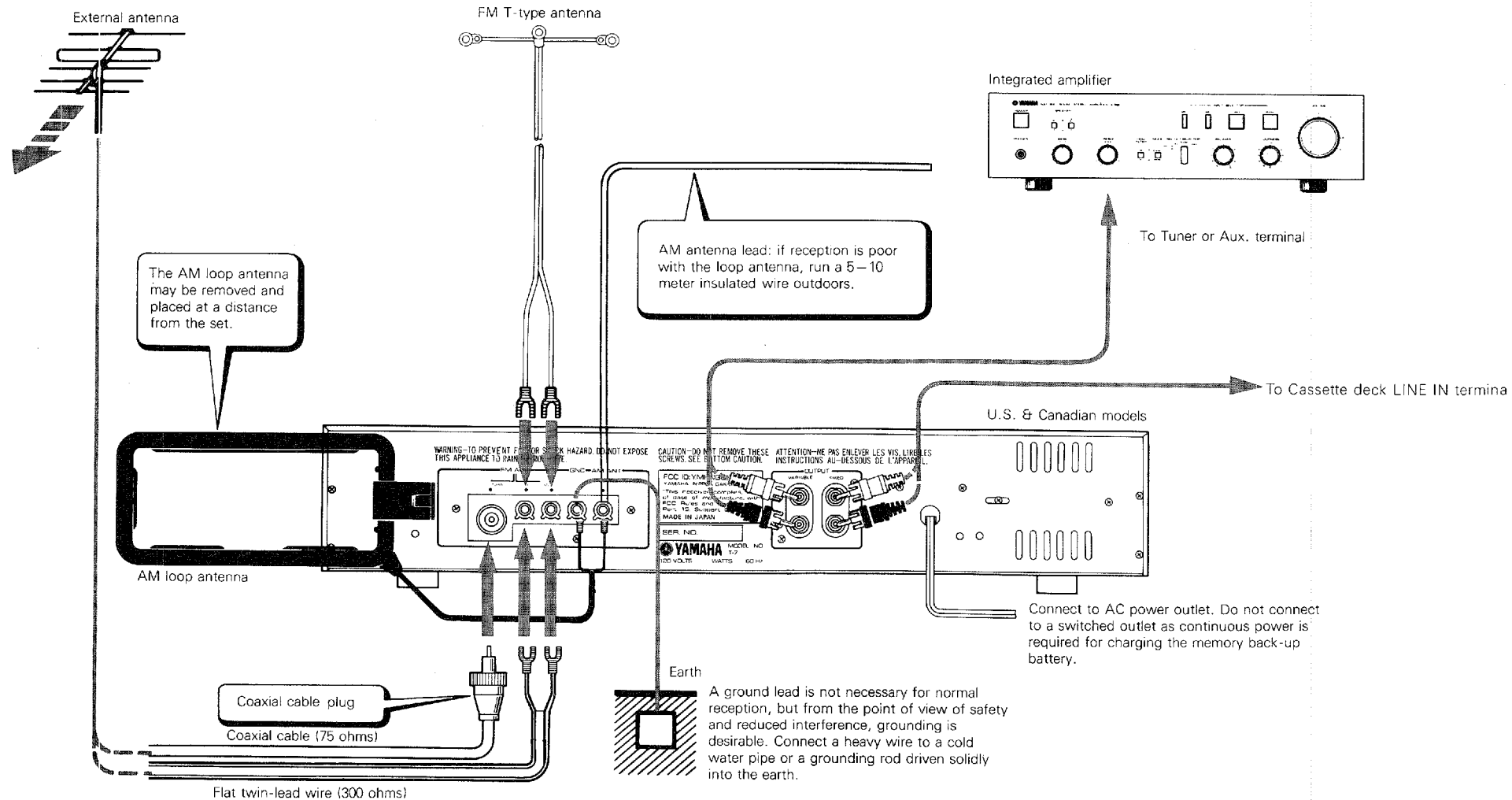

Fig. 1

T-7

CONNECTION DIAGRAM



CONNECTING THE AMPLIFIER

The T-7 has two sets of output jacks for connection to your stereo amplifier. Use the cable supplied to connect from the "Fixed" jacks to the Tuner input jacks of your amplifier, being sure to observe the left and right channel markings. Also make sure that the connections are secure and that the connecting cable is not bundled together with the speaker leads from the amplifier. Later, if it is desired to match the output signal level of the tuner to that of some other source such as a turntable, change the cable to the "Variable" jacks and adjust the control on the bottom panel until equal volume is obtained with the two sources. This should eliminate having to adjust the volume control when switching from one source to another.

CONNECTING THE FM ANTENNA

Choose an FM antenna that is appropriate to the local reception conditions. Consider the distance from the broadcast station and possible interfering objects such as surrounding tall buildings. In cases where there is a strong signal from a local station, a portable T-type antenna is usually adequate. Connect the feeder wire to the 300 ohm terminal, stretch the wire out tight, and turn to obtain optimum reception. Attach to a suitable support such as a wall.

In all but the best reception conditions, an outdoor FM antenna is necessary for best results. Either 300 ohm flat twin-lead wire or 75 ohm coaxial cable may be used. In locations where electrical interference is a problem, coaxial cable is preferable. Refer to fig. 2 for instructions on installing the coaxial cable plug.

CONNECTING THE AM ANTENNA

In many cases it will be possible to get excellent AM reception with the attached AM loop antenna. Attach the antenna leads to the Gnd and AM Ant terminals and rotate the antenna in its bracket for best reception. The loop antenna may also be removed and hung on the wall.

If necessary, an outdoor antenna may be used for improved AM reception. Connect a 5-10 meter length of insulated wire to the AM Ant terminal and run it outdoors.

T-7 NAMES OF THE PARTS AND THEIR FUNCTIONS

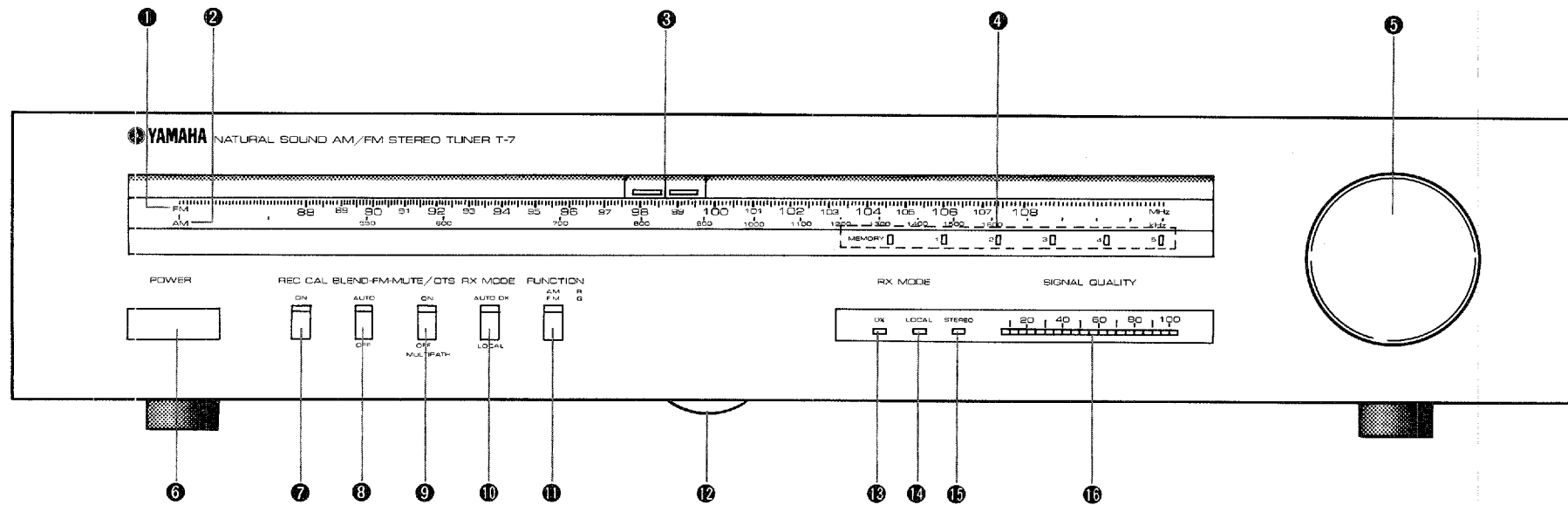

① FM DIAL SCALE

The received FM frequency is shown in MHz (megahertz).

② AM DIAL SCALE

The received AM frequency is shown in kHz (kilohertz).

③ TUNING INDICATOR

The pointer shows the FM or AM frequency, and 2 green LEDs indicate precise tuning by lighting up with equal brightness. In cases where the signal level is weaker than the muting level, the LEDs will not light.

④ PRESET TUNING BUTTONS

5 FM stations and 5 AM stations can be memorized. When a preset tuning button is pushed, the corresponding station will be immediately tuned in.

⑤ TUNING KNOB

This knob selects the desired broadcast station. While looking at the Signal Quality Indicator and the Tuning Indicator, turn the knob to obtain optimum reception. The Optimum Tuning System (OTS) detects your touch on the tuning dial and turns off the circuit temporarily to allow precise tuning.

⑥ POWER

This is a "push-on, push-off" type power switch.

NOTE: On British, North European and Australian models, the switch is labeled "ON" and "STANDBY".

⑦ REC CAL

This switch activates a test signal of 333 Hz corresponding to 50% FM modulation that can be used to accurately set recording levels before tape recording an FM broadcast. Before recording, turn the switch on and adjust your tape deck for a level meter reading of between -6 VU and 0 VU. The Rec Cal switch should be left off when not in use.

⑧ BLEND

When listening to a weak, noisy stereo broadcast, this circuit can be used to reduce high-frequency hiss at the expense of a slight reduction in stereo separation. When the switch is set to Auto, the received signal level is automatically monitored, and if it is weak the Blend circuit will be activated to reduce hiss. In the Off position, the switch provides best stereo separation.

⑨ MUTE/OTS

This switch has three functions: FM muting, OTS, and multipath detection. The switch should normally be left on. The FM muting circuit turns off the sound completely when a strong station is not being received, thereby eliminating interstation noise. In order to receive a very weak station it is necessary to turn the switch to the Off/Multipath position to defeat the muting function.

The Optimum Tuning System is a Yamaha exclusive feature which provides exceptionally accurate tuning. An automatic circuit detects any mistuning and actually readjusts the tuned frequency to correct the problem. OTS detects your touch on the tuning dial and temporarily unlocks to allow manual tuning, then locks your station in perfectly when you release the dial. When tuning in a weak station adjacent to a strong one, the stronger station may tend to pull OTS away from the desired station. In this case, set the Mute/OTS switch to Off/Multipath to disable the OTS circuit.

The T-7 incorporates a Signal Quality Indicator which detects the presence of multipath interference (see page 7). The Mute/OTS switch must be set to the Off/Multipath position for this function.

⑩ RX MODE

The RX Mode (reception mode) switch lets you adjust the T-7's IF stages for best results on either strong or very weak stations.

In the Auto DX position the received signal strength is monitored continuously, and if it falls below a certain level a high-gain, high-selectivity circuit is switched in which provides the best possible reception of weak, noisy stations. On stronger signals this circuit is automatically deactivated, for improved distortion and stereo separation. On AM broadcasts this switching is not automatic; switch manually from DX to Local.

In the Local position the T-7 is set up to provide best results with strong, local stations. Accurate music reproduction with low distortion and good stereo separation will be achieved.

⑪ FUNCTION

This switch selects either FM or AM broadcasts. An indicator lights green when FM is selected and red when the T-7 is switched to AM.

⑫ OUTPUT VARIABLE

This control on the bottom panel allows you to adjust the "Variable" terminal output level over the range of 0.1–1 V (measured at FM 100% modulation). The center click stop corresponds to a level of 500 mV.

⑬ DX

This indicator lights to show that the T-7 is in DX mode.

⑭ LOCAL

When the RX Mode switch (⑩) is in the Local position or when the received station is sufficiently strong, the indicator lights up to denote Local mode.

⑮ STEREO

When an FM stereo broadcast is being received this indicator automatically lights.

⑯ SIGNAL QUALITY

When tuning in a station, adjust the tuning knob until the indicator lights up as far to the right as possible. Refer to page 7 for a detailed description.

T-7 RX MODE/ SIGNAL QUALITY INDICATOR/ MULTIPATH INTERFERENCE

RX MODE

Ideally, a tuner should provide the best possible reception under all listening conditions. In practice, however, this is difficult to achieve. When receiving a weak, noisy station, it is desirable for the tuner to have high selectivity, as this allows it to reject outside interference and provide clear reception. When a strong station is received, it is better for the tuner to have low selectivity, because this provides more accurate, distortion-free music reproduction and increases stereo separation. Conventional tuners have a constant selectivity value which is a compromise, providing reception that is adequate under most signal conditions but is less than ideal. The T-7 solves this problem with its dual-selectivity IF amplifier. With the RX Mode switch, you can optimize the tuner for either weak or strong stations, providing the best possible performance either way. See page 6 for an explanation of how to use the switch.

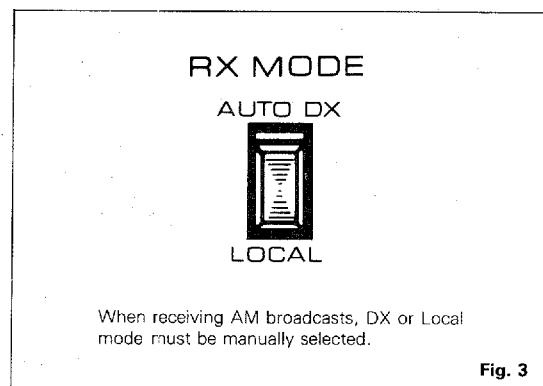

SIGNAL QUALITY INDICATOR

This dual purpose indicator shows the signal strength of the received station and also can be used to detect multipath interference.

When the Mute/OTS switch is on the indicator works as a signal strength meter and indicates the approximate antenna input.

When the Mute/OTS switch is at the Off/Multipath position the multipath interference detection circuit is engaged. The signal strength indication is dimmed, and if there is multipath interference the left-hand portion of the indicator will light up as shown in fig. 4. In order to get the best possible reception, it is desirable to eliminate any multipath interference either by rotating the antenna or by replacing the antenna with one that is more directional.

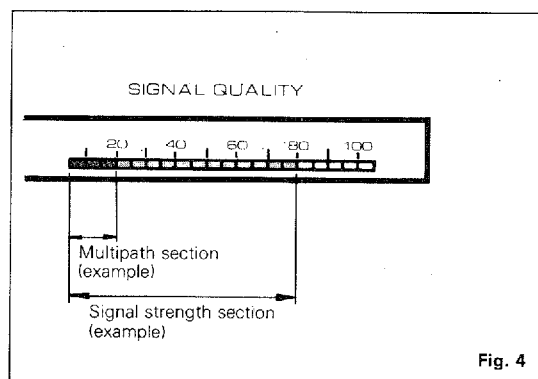

MULTIPATH INTERFERENCE

Multipath is an effect similar to television ghosting; it distorts the received signal and also causes poor stereo separation and noise. As shown in fig. 5, radio waves which travel directly from the transmitter to the receiving antenna are mixed with waves which reflect off nearby objects such as buildings. Because the path taken by the reflected waves is longer than the direct path, the time required for the waves to arrive at the antenna is also longer. The mixing of the directly received signal and the delayed signal noticeably degrades reception quality. Multipath interference can be greatly reduced by the use of a high-quality directional antenna oriented in the proper direction. To assist you in diagnosing antenna problems, Yamaha provides a Signal Quality Meter (see previous section) for detecting multipath interference.

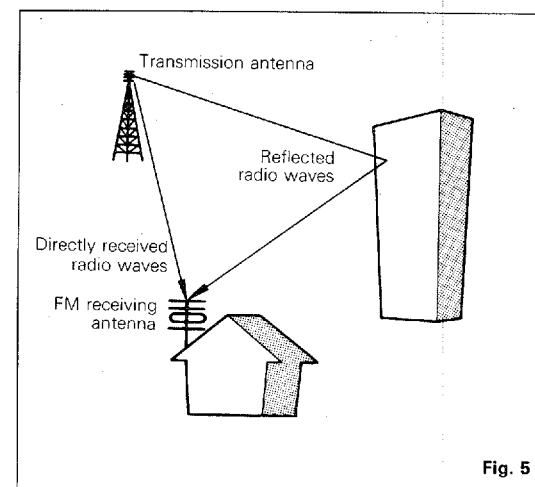

T-7 PRESET TUNING/ MEMORY BACKUP POWER SUPPLY

PRESET TUNING

In addition to having a conventional tuning knob for selecting stations, the T-7 has a convenient preset tuning system which allows you to tune in your favorite stations with the touch of a button.

To preset a station into the memory, first tune the station in manually. Check to see that the station has been tuned accurately for the best possible reception. While pressing the Memory button, press one of the numbered preset tuning buttons. The tuner will then memorize the station's frequency. Any time the appropriate numbered button is pressed, the station will automatically be tuned in. After you have preset a station, it is a good idea to manually change to another frequency and then push the newly memorized station's button again to see that it is tuned in correctly. Up to 5 AM and 5 FM stations can be preset—a total of 10. In other words, each numbered button selects one of two stations—one FM and one AM—depending on which band has been selected by the Function switch.

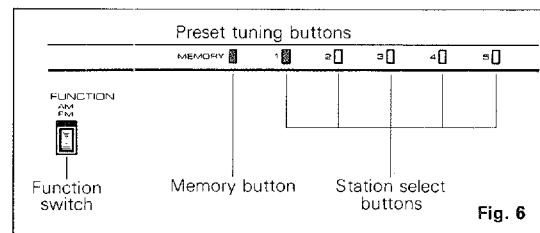

To tune in a previously memorized station, first make sure that the Function switch is set for FM or AM as appropriate. The indicator will light up green for FM and red for AM. Then press the numbered button corresponding to the desired station. The tuning indicator will automatically move to the correct frequency and the station will be tuned in. The preset tuning button will light to indicate automatic station selection. Turning the manual tuning knob turns the light off, and a new station can be tuned in manually.

There may be cases where static electricity or electrical noise from fluorescent lamps or television sets prevent successful preset tuning. Set the tuner away from such sources of interference. When the button pressed has been preset to a very weak station or there is no broadcast station at the memorized frequency, the frequency tuned in may deviate slightly from the memorized frequency. If after a station has been tuned in automatically the unit is subjected to excessive

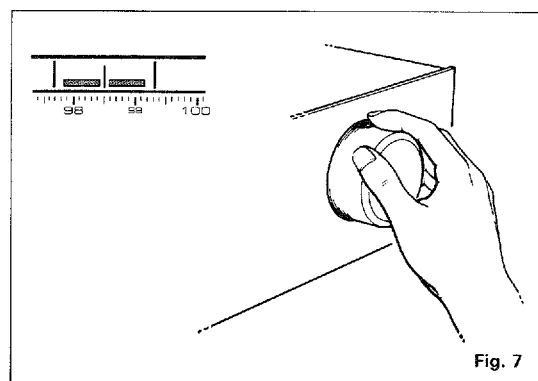

vibration or if the tuning knob is turned with an insulated object such as a pencil, it may not be possible to tune the station in again automatically. This can be easily corrected by selecting another station first and then pushing the button of the desired station.

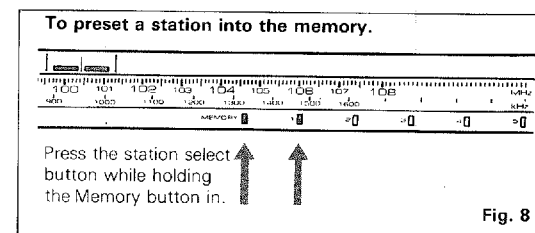

MEMORY BACKUP POWER SUPPLY

In order to remember the frequencies of preset stations even when the unit is switched off, the T-7 continues to draw a small amount of power when off. In order to protect the memory contents in the event of a power failure a rechargeable battery is used. The tuner should be plugged in whenever possible to keep this memory backup battery fully charged. If the tuner is normally turned on and off with a switched AC outlet or with a timer, the battery will not be charged, and the preset memory will be erased about two hours after the unit is turned off. When the battery is fully charged (charging time about 3 days) the memory will be retained for about 4 months. When the unit is first purchased the battery will require charging time. It can be charged by plugging in the power cord to a wall outlet (the power switch does not need to be on).



TROUBLESHOOTING

Before assuming that your tuner is faulty, check the following troubleshooting list which details the corrective action you can take yourself without having to call a service engineer. If you have any doubts or questions, get in touch with your nearest YAMAHA dealer.

	Fault	Cause	Cure
FM	Crackling sounds from time to time (especially in weak signal areas).	Ignition noise from vehicles.	The FM antenna should be put up as high as possible, away from the road, and a coaxial cable used.
		Noise from thermostats and other electrical equipment.	Attach a noise suppressor to the equipment causing the noise.
	Noisy reception of stereo broadcasts.	Stereo is especially susceptible to noise when the received signal is weak.	Use a high-quality directional FM antenna.
			Place the RX Mode switch in the Auto DX position.
			Place the Blend switch in the Auto position.
	The FM Stereo indicator flickers on and off and reception is noisy.	Insufficient antenna input.	Use an antenna appropriate for the reception conditions in your area.
		Not tuned correctly.	Tune again.
	There is distortion and clear reception cannot be obtained even with a good FM antenna.	There is multipath interference.	Adjust antenna placement to eliminate multipath interference (see page 7).
	Sounds from the left side leak to the right.	A certain amount of crosstalk is normal.	If the effect is small, there is no trouble.
	The Signal Quality Indicator lights up but there is no sound.	The muting circuit has turned off the sound because the received station is very weak.	Place the Mute/OTS switch in the Off/Multipath position to disable muting.
	The volume is very low.	The amplifier volume control is too low.	Readjust.
		The Output Variable control on the bottom panel is too low.	Readjust (see page 6).
Only one side of the tuning indicator lights up.	Not tuned correctly.	Tune the station precisely.	
	The preset station called out was not properly memorized.	Repeat the preset procedure.	
Automatic station selection does not work.	The memory has been erased because the tuner was not plugged in for an extended time.	Repeat the preset procedure.	
	You are touching the tuning knob while pressing the preset tuning button.	Do not touch the tuning knob when automatically tuning a preset station.	
AM	The received station is weak and noisy.	The signal is too weak.	Change the direction of the AM loop antenna. Use an outdoor antenna.
		These noises result from lightning, fluorescent lamps, motors, thermostats and other electrical equipment.	Use an outdoor antenna and a ground wire. This will help somewhat but it is difficult to eliminate all noise.
	There are buzzing and whining noises (especially during the evening).	Another station is interfering with the received station.	This is impossible to remedy.
A television set is being used nearby.		Move the television a distance away.	

T-7 SPECIFICATIONS

FM SECTION

Tuning Range	87.6 to 108 MHz		
50 dB Quietening Sensitivity			
Mono (DX)	3.2 μ V (15.3 dBf)		
Stereo (DX, Blend on)	20 μ V (31.2 dBf)		
(DX, Blend off)	38 μ V (36.8 dBf)		
Usable Sensitivity			
IHF Mono (98 MHz, 40 kHz dev.)	1.7 μ V (300 ohms) 9.8 dBf		
	0.85 μ V (75 ohms) 9.8 dBf		
DIN Mono (40 kHz dev., S/N 26 dB)	1.2 μ V		
Stereo (40 kHz dev., S/N 46 dB)	35 μ V		
Image Response Ratio (98 MHz)	100 dB		
IF Response Ratio (98 MHz)	100 dB		
Spurious Response Ratio (98 MHz)	100 dB		
AM Suppression Ratio (IHF)	67 dB		
Capture Ratio (IHF)	1.5 dB		
Alternate Channel Selectivity	IHF	Local 55 dB,	DX 90 dB
	DIN	Local 30 dB,	DX 70 dB
Signal-to-Noise Ratio (at 85 dBf)			
Mono	90 dB		
Stereo	85 dB		
DIN (40 kHz dev.) Mono	84 dB		
Stereo	79 dB		
Distortion			
Mono	100 Hz	Local 0.03%,	DX 0.1%
	1 kHz	Local 0.04%,	DX 0.3%
	6 kHz	Local 0.07%,	DX 0.7%
	10 kHz	Local 0.05%,	DX 0.1%
Stereo	100 Hz	Local 0.04%,	DX 0.5%
	1 kHz	Local 0.04%,	DX 0.5%
	6 kHz	Local 0.07%,	DX 0.8%
	10 kHz	Local 0.08%,	DX 1.5%
	15 kHz	Local 0.2%,	DX 3.0%
Intermodulation Distortion (IHF)			
Mono	Local 0.04%, DX 0.5%		
Stereo	Local 0.04%, DX 1.0%		
Stereo Separation			
DC to 1 kHz	Local 60 dB, DX 30 dB		
2 kHz to 10 kHz	Local 52 dB, DX 25 dB		
Frequency Response			
50 Hz to 10 kHz	\pm 0.3 dB		
20 Hz to 15 kHz	+0.3, -0.5 dB		

10 Hz to 18 kHz	+0.5, -3.0 dB
Subcarrier Product Ratio	70 dB
Muting Threshold (DX)	5 μ V (19.2 dBf)
Auto-DX Threshold	50 μ V (39.2 dBf)

AM SECTION

Tuning Range	525 to 1,605 kHz	
Usable Sensitivity (IHF)	15 μ V	
Alternate Channel Selectivity		
1,000 kHz \pm 10 kHz	Local 17 dB,	DX 27 dB
Signal-to-Noise Ratio	52 dB	
Image Response Ratio	50 dB (1,000 kHz)	
Spurious Response Ratio	50 dB	
Distortion	0.3%	

AUDIO SECTION

Output Level/Impedance		
FM (100% mod. 1 kHz)	1 V/600 ohms (Fixed)	
	500 mV/3.3 k-ohms (Variable center)	
	1 V/600 ohms (Variable max.)	
AM (30% mod. 1 kHz)	300 mV/600 ohms (Fixed)	
	150 mV/3.3 k-ohms (Variable center)	
	300 mV/600 ohms (Variable max.)	
Rec Cal Signal (333 Hz:	500 mV/600 ohms (Fixed)	
Corresponding to 50%	250 mV/3.3 k-ohms (Variable center)	
FM modulation)		

GENERAL

Semiconductors	86 Transistors, 20 ICs, 4 FETs, 38 Diodes, 3 Zener Diodes, 14 LEDs.	
Power Supply		
U.S. & Canadian Models	120 V, 60 Hz	
General Model	110 ~ 130 V/220 ~ 240 V, 50/60 Hz	
North European Model	220 V, 50 Hz	
British & Australian Models	240 V, 50 Hz	
Power Consumption		
U.S. & Canadian Models	14 W	
General, North European British & Australian Models	16 W	
Dimensions (W x H x D)	435 x 95 x 335 mm (17-1/8" x 3-3/4" x 13-1/8")	
Weight	5.2 kg (11 lbs. 7 oz.)	

Specifications subject to change without notice

T-7 AM/FM STATION MEMORY CARD

FM 1 2 3 4 5

MHz

STATION

AM 1 2 3 4 5

KHz

STATION

DATE _____



T-7 AM/FM STATION MEMORY CARD

FM 1 2 3 4 5

MHz

STATION

AM 1 2 3 4 5

KHz

STATION

DATE _____



This card has been provided for your convenience in recording the names and frequencies of stations that have been preset into the T-7's programmable memory. Refer to page 8 for preset procedure.



T-7 AM/FM STATION MEMORY CARD

FM 1 2 3 4 5

MHz

STATION

AM 1 2 3 4 5

KHz

STATION

DATE _____



T-7 AM/FM STATION MEMORY CARD

FM 1 2 3 4 5

MHz

STATION

AM 1 2 3 4 5

KHz

STATION

DATE _____



SINCE 1887  **YAMAHA**
NIPPON GAKKI CO., LTD. HAMAMATSU, JAPAN