

Accuphase

STEREO TUNER T-100

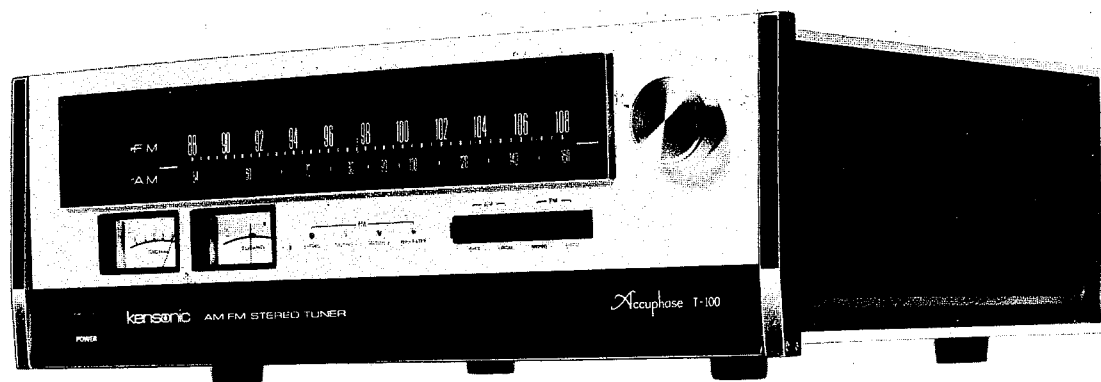

Service Information

STARTING WITH SERIAL NO. 13Y001

TABLE OF CONTENTS

BLOCK DIAGRAM	1
EXTERNAL VIEW	2
INTERNAL VIEW	3
EXPLODED VIEW	4
MISCELLANEOUS	6
HOW TO RE-STRING THE DIAL MECHANISM	6
HOW TO REPLACE THE METERS	7
POWER SUPPLY ASSEMBLY	7
AM FM FRONT-END	8
(FM PRINTED CIRCUIT BOARD, AM PRINTED CIRCUIT BOARD)	8
DELAY FUSE ASSEMBLY	9
FM IF and METER CIRCUIT ASSEMBLY	10
MPX and SUBCIRCUIT ASSEMBLY	12
AM IF ASSEMBLY	14
AUDIO AMP. ASSEMBLY	15
CIRCUIT DESCRIPTION	16
RESISTOR COLOR CODE	21
SEMI-CONDUCTOR LEADS	22
SCHEMATIC DIAGRAM	23
SPECIFICATIONS	25

EXTERNAL VIEW

FRONT

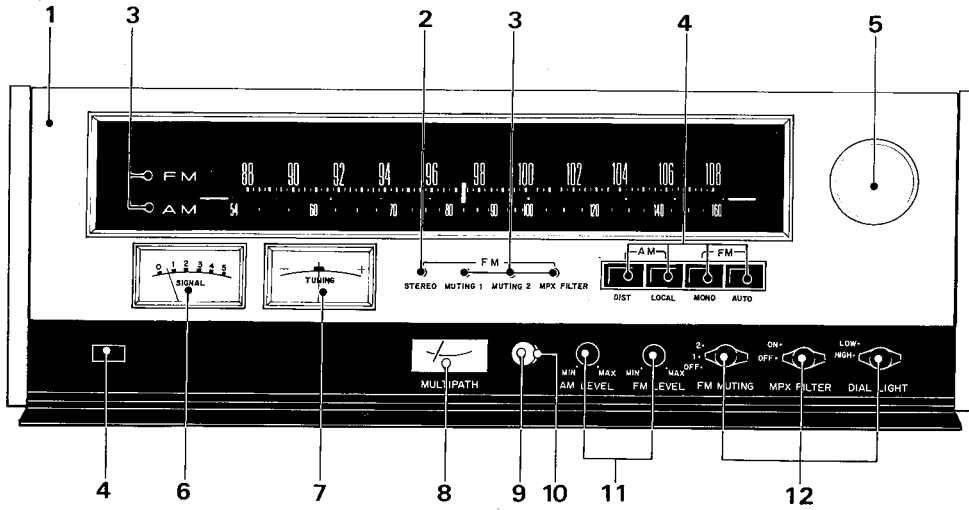

REAR

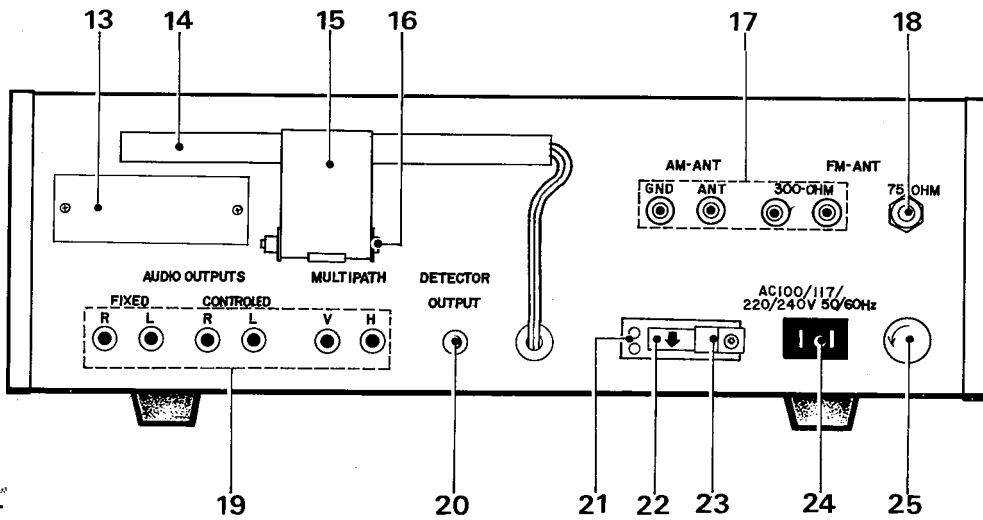

PARTS LIST

Ref. No.	Description	Part No.	Remarks
1	Front Panel Assembly	130-0003-02	
2	Position Indicator	173-0201-04	Red FM STEREO
3	Position Indicator	173-0901-04	White AM FM MUTING 1, 2 MPX FILTER
4	Push button	389-5001-04	for Power Switch Push Button Assembly
5	Knob	381-4002-04	Tuning
6	SIGNAL Meter	178-0001-00	
7	TUNING Meter	178-1001-00	
8	MULTIPATH Meter	178-9001-00	
9	Magnet	271-0001-00	
10	Push button	389-1202-04	with Magnet
11	Knob	384-1201-04	AM, FM LEVEL
12	Knob	384-1101-04	FM MUTING, MPX FILTER DIAL LIGHT
13	Set Name Plate	181-0003-04	
14	AM Loop Stick Antenna	508-0001-00	
15	Antenna Holder	249-0001-00	for AM Loop Stick Antenna
16	Fixed Bracket	247-0013-03	for AM Loop Stick Antenna
17	Antenna Terminal	313-0021-00	for AM, FM 300 Ω
18	Coaxial Connector, Receptacle	302-7001-00	for 75 Ω Coaxial cable
19	PinJack	302-0201-00	for Output Terminal: FIXED CONTROLLED, MULTIPATH
20	PinJack	302-0101-00	for DETECTOR OUTPUT
21	Voltage Selector Jack	302-4001-00	
22	Voltage Selector Plug	301-4001-00	
23	Voltage Selector Fixed Bracket	248-0001-04	
24	AC Connector Plug	301-3201-00	
25	Fuse Holder	306-0101-00	for MAIN fuse

INTERNAL VIEW

TOP SIDE

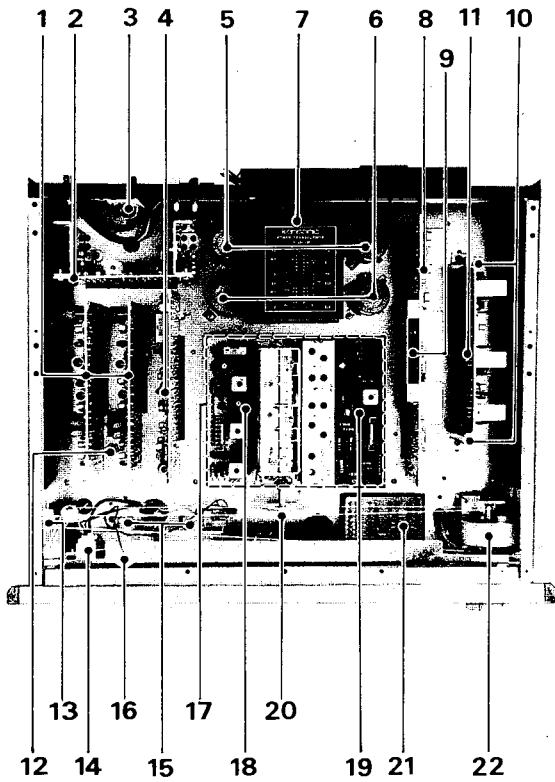

BOTTOM SIDE

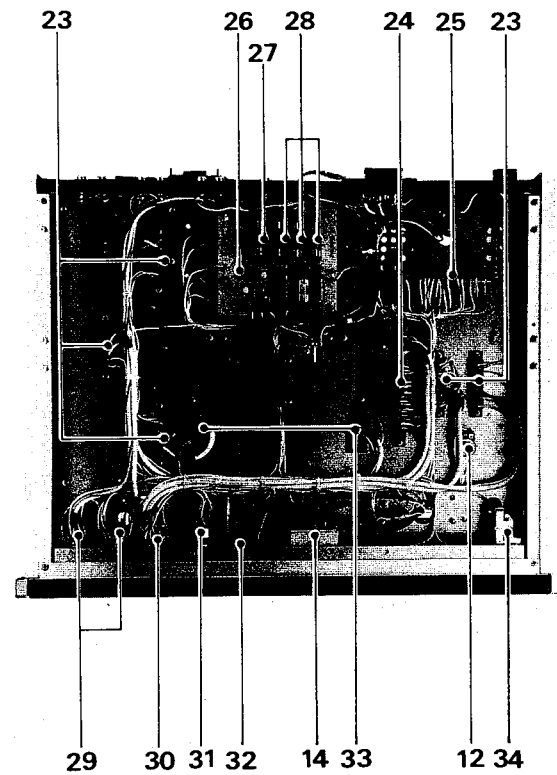

PARTS LIST

Ref. No.	Description	Part No.	Remarks
1	Audio AMP. Assembly	714-0003-00	Outside (L), Inside
2	Power AMP. Assembly	719-0003-00	
3	Balun Transformer Assembly	708-0001-00	
4	MPX and Sub Circuit Assembly	706-0001-00	
5	Electrolytic Capacitor 3300 μ F 25WV	CE62W1E332	C5, 6
6	Electrolytic Capacitor 3300 μ F 35WV	CE62W1V332	C3, 4
7	Power Transformer	510-0001-00	T1
8	FM IF AMP. Assembly	703-0001-00	
9	Printed Circuit Board Fixed Bracket	248-0009-04	for FM IF Assembly
10	Printed Circuit Board Fixed Bracket	248-0004-04	for AM IF Assembly
11	AM IF AMP. Assembly	704-0001-00	
12	Variable Resistor 500k Ω B	570-1801-00	for VR3: MPX separation adjust
13	Small Pulley	201-1401-00	
14	Pilot Lamp 8V 150 mA	176-4401-00	for AM FM position, MULTIPATH STEREO, MUTING, MPX, FILTER for SIGNAL, TUNING meter
15	Pilot Lamp 8V 300 mA	176-5401-00	
16	Dial pointer Assembly	206-0001-00	
17	AM FM front-end Assembly	702-0002-00	
18	AM, Front-end	709-1001-00	AM FM Front-end Assembly
19	FM, Front-end	709-0001-00	AM FM Front-end Assembly
20	Tuning Capacitor Drum	200-5401-00	with Tension Spring
21	Push button Assembly	716-0010-00	
22	Tuning Shaft Assembly	203-0001-03	included Flywheel
23	Printed Circuit Board Connector	303-1001-00	10-pin
24	Printed Circuit Board Connector	303-2201-00	22-pin
25	Printed Circuit Board Connector	303-1801-00	18-pin
26	Delay Fuse Assembly	716-0005-00	
27	Fuse 3A	310-0301-00	Delay Fuse Assembly
28	Fuse 1A	310-0101-00	Delay Fuse Assembly
29	Rotary Switch	332-2001-00	for MPX-FILTER, DIAL LIGHT
30	Rotary Switch	332-3002-00	for FM MUTING
31	Variable Resistor 10k Ω Bx2	573-210-00	for VR2: FM LEVEL
32	Variable Resistor 10k Ω B	573-1102-00	for VR1: AM LEVEL
33	Connector Plug	304-0401-00	for AM, FM Front-end Assembly
34	Push button Switch	354-1002-00	S6: POWER switch

EXPLODED VIEW

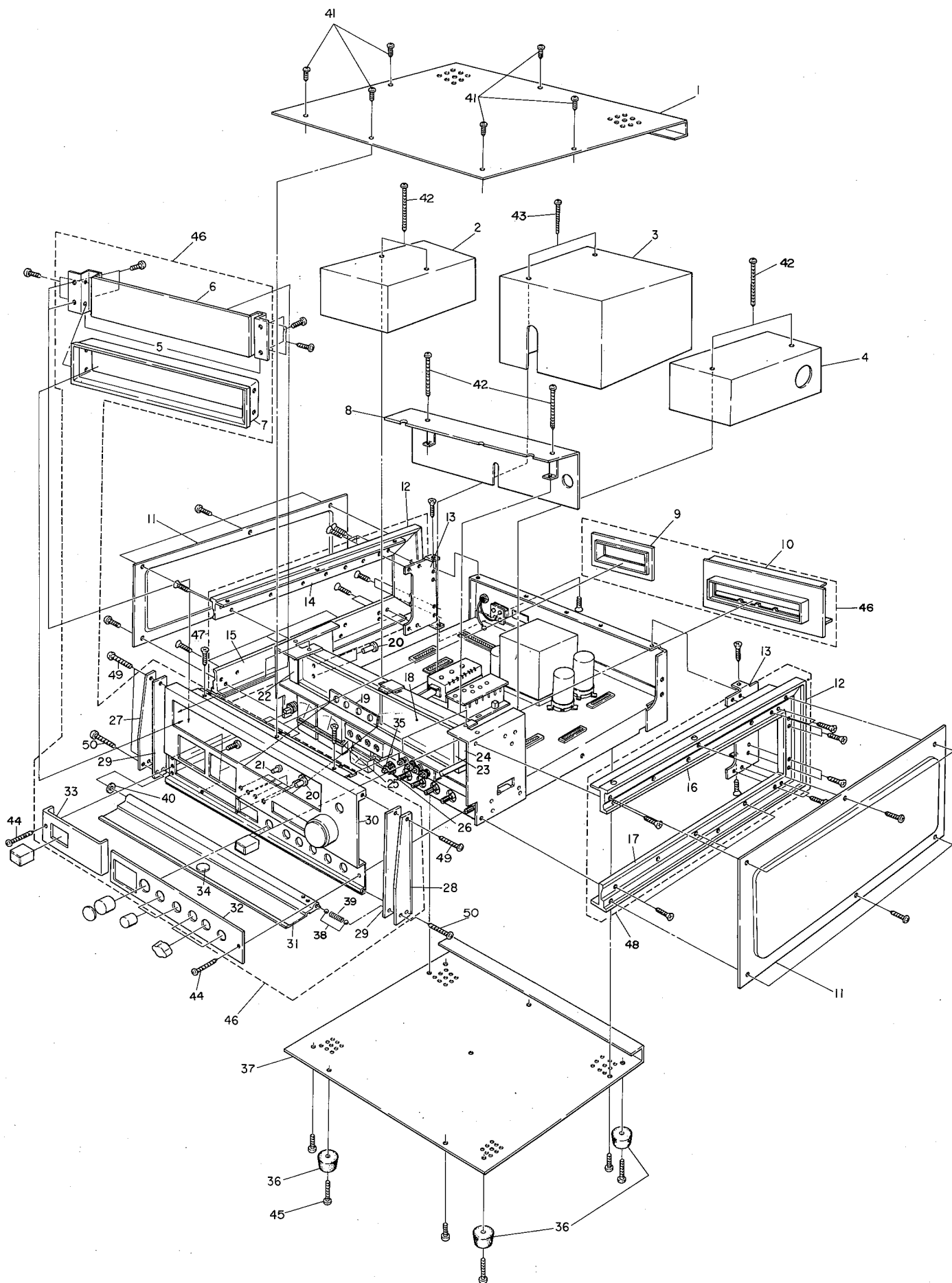

PARTS LIST

Ref. No.	Description	Part No.	Remarks
1	Top Plate	150-0001-02	
2	Shield Case (L)	231-0001-03	
3	Front end Shield Case	231-0006-03	
4	Shield Case (R)	231-0005-03	
5	Front Glass Fixed Bracket	248-0010-04	
6	Front Glass	172-0001-03	Front Panel Assembly
7	Dial Frame	112-6001-00	Front Panel Assembly
8	Dial Shield Cover	2301-005-02	Front Panel Assembly
9	Meter Frame	113-0005-03	Front Panel Assembly
10	Push Button Frame	113-0003-03	Front Panel Assembly
11	Side Plate	151-0001-02	
12	Frame (C)	112-1003-04	Frame Assembly (L, R)
13	Frame Fixed Bracket	244-0001-04	Frame Assembly (L, R)
14	Frame (A)	112-1001-13	Frame Assembly(L): for Upper
15	Frame (B)	112-1002-13	Frame Assembly(L): for Bottom
16	Frame (D)	112-1004-13	Frame Assembly(R): for Upper
17	Frame (E)	112-1005-13	Frame Assembly(R): for Bottom
18	Dial Glass	175-2001-03	
19	Position Indicator Fixed Bracket	248-0011-04	Front panel Assembly
20	Position Indicator	173-0901-04	
21	Position Indicator	173-0201-04	Front panel Assembly: Red for MPX
22	Dial Glass Fixed Bracket (L)	248-0005-04	Fixed for Left Side
23	Dial Glass Fixed Bracket (R)	248-0006-04	Fixed for Right Side
24	Pilot Lamp	176-2301-00	for Dial Light
25	Meter Fixed Bracket (A)	248-0007-04	for SIGNAL, TUNING meter
26	Meter Fixed Bracket (B)	248-0008-04	for MULTIPATH
27	Panel End Cap (L)	132-0001-00	Front panel Assembly : for Left Side
28	Panel End Cap (R)	132-0002-00	Front panel Assembly : for Right Side
29	Panel End Spacer	250-1001-14	Front panel Assembly
30	Front Panel	131-0003-02	Front panel Assembly
31	Sub Panel	134-0003-12	Front panel Assembly
32	Panel Name Plate	180-1003-14	Front panel Assembly
33	Meter Cover	254-2001-03	Front panel Assembly Cach
34	Cacher	272-0001-04	Front panel Assembly for Sub Panel Magnet
35	Push button Switch	354-1201-00	Opener for Sub Panel Magnet Opener
36	Rubber Foot	238-0001-04	
37	Bottom Plate	155-0001-02	
38	Ball Bearing	220-0301-00	Front panel Assembly
39	Coil Spring	285-1001-04	Front panel Assembly
40	Nylon Washer	637-1031-05	Front panel Assembly
41	Binding Head B type Self Tapping Screw	600-0306-02	3x6mm Fixed for Top, Side, Button, Plats
42	Pan Head ISO Metric Screw	614-0390-01	3x90mm Fixed for Shield Cover
43	Pan Head ISO Metric Screw	600-0375-01	3x75mm Fixed for Shield Cover
44	Binding Head B type Self Tapping Screw	600-0310-00	3x10mm Fixed for Front Panel Assembly
45	Pan Head ISO metric Screw	600-0414-01	4x10mm Fixed for Plastic Feet
46	Front Panel Assembly	130-0003-00	
47	Frame Assembly(L)	112-0001-02	
48	Frame Assembly(R)	112-0002-02	
49	Pan Head B type Self Tapping Screw	610-0314-01	Fixed for Front-end Cap Rear Side
50	Pan Head ISO Metric Screw	615-0312-01	Front Panel Assembly: 3x12mm Fixed for Panel End Cap Front Side

MISCELLANEOUS

PARTS LIST

Ref. No.	Description	Part No.	Remarks
	Meter Filter	179-0004-04	for MULTIPATH
	Meter Filter	179-0002-04	for SIGNAL TUNING meter
	Dial Glass Filter	179-0007-04	for Dial Glass
	Tuning Shaft Assembly	203-0001-03	
	Dial String	210-0001-00	
	Pulley Bushing	221-0601-04	
	Coaxial Connector Plug	301-7001-00	for 75 Ω Coaxial cable
	Pilot Lamp Socket	305-2201-00	
	Fuse 0.5A SLO-BLO	310-1051-00	for Main fuse at 100V, 117V
	Fuse 1/4A SLO-BLO	310-1141-00	for Main fuse at 220V, 240 V
	Terminal Strip	314-0101-00	
	Lug Strip	315-1011-00	
	Lug Strip	315-2021-00	
	Power Supply Cord	680-1201-00	
	Stereo Cord	685-0401-00	4-plug
	Carbon Film Resistor 15k Ω \pm 5% 1/2W	RD142HA153J	R1
	Carbon Film Resistor 13k Ω \pm 5% 1/2W	RD142HA133J	R2
	Carbon Film Resistor 100k Ω \pm 5% 1/2W	RD142HA104J	R4
	Carbon Film Resistor 3.3 Ω \pm 5% 1W	RN143AA3R3J	R3
	Electrolytic Capacitor 4.7 μ F 35WV	CE02W1V4R7	C2
	Mylar Film Capacitor 82000pF \pm 5% 50WV	CQ93M1H823J	C1
	Mylar Film Capacitor 0.01 μ F 250 WV	CQ93M2E103MUL	C7
	Balun Transformer	509-0001-00	

HOW TO RE-STRING THE DIAL MECHANISM

FOLLOW THE DIRECTIONS BELOW IN THE ORDER OUTLINED.

1. Prepare a dial string about 2.5 meters long (8 feet 6 inches).
2. Tie one side of the string to the tension spring, leaving about 10 cm (4 inches) of the string end free.
3. Set the tuning capacitor to full clockwise.
4. Turn the dial drum clockwise until the string is in the bottom groove of the variable capacitor drum on the way.
5. Turn the dial drum clockwise until the string is in the bottom groove of the variable capacitor drum on the way.
6. The string should then be led back to the top side of the drum and wound around it twice just behind

HOW TO REPLACE THE METERS

When necessary, the SIGNAL, TUNING or MULTI-PATH meters can be removed for repair or replacement as follows.

1. Remove all knobs from the front panel of the T-100. (TUNING plus 5 others on the sub-panel).
2. Remove the Top Plate. (Do not misplace the nylon washers).
3. Remove one screw each from the left and right side panels. These screws are located at the upper end, adjacent to the front side. These are the screws that hold up the front panel assembly.
4. Remove the two front panel screws No. 44 (Ex-

ploded view: page 4) which hold the front panel assembly in place from the frontside.

5. Remove the two screws that are affixed to the front panel assembly from the bottomside.
6. Now remove the front panel assembly itself.
7. Remove the metal plate holding the meter in place. This is No. 25 for the Signal meter and No. 26 for the Multipath meter on the assembly Exploded view on page 4.
8. Replace or repair meter.
9. Reattach meter and front panel assembly in reverse order, as explained above, starting from step 7.

POWER SUPPLY ASSEMBLY (719-0003-00) PRINTED CIRCUIT BOARD

*Printed circuit board as seen from the reverse side.

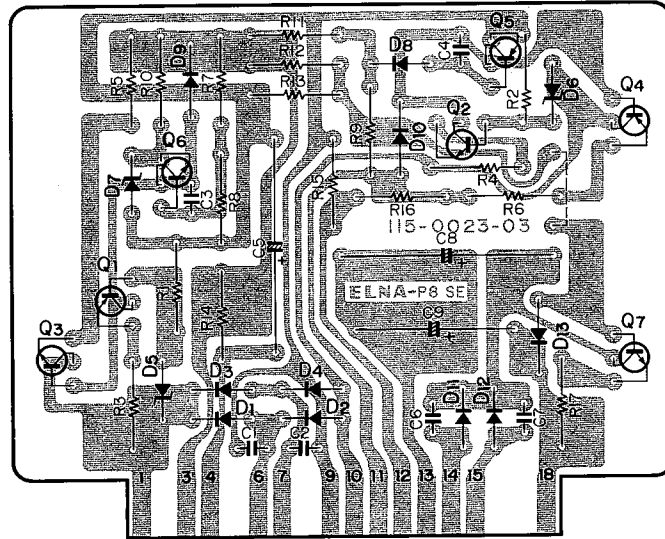

PARTS LIST

Ref. No.	Description	Part No.	Remarks
	Heatsink	240-1006-04	for 2SB435, 2SD235
	Transistor Insulator	381-0201-00	for 2SB435, 2SD235
	Transistor Insulation washer	318-1102-00	for 2SB435, 2SD235
Q1, 5	Transistor PNP	2SA661, O. Y or GR	
Q4	Transistor PNP	2SB435, O or Y	
Q2, 6	Transistor NPN	2SC1166, O. Y or GR	
Q3, 7	Transistor NPN	2SD2350 or Y	
D1, 2, 3, 4, 11, 12	Silicon Diode	1BZ61	
D8	Silicon Diode	1S1555	
D5, 6	Silicon Diode	1S330	
D7	Zener Diode	XZ-060	
D9, 10, 13	Silicon Varistor	SV-02	
R14	Carbon Film Resistor 220Ω ±5% 1/2W	RD142HA221J	
R3	Carbon Film Resistor 560Ω ±5% 1/2W	RD142HA561J	
R12	Carbon Film Resistor 620Ω ±5% 1/2W	RD142HA621J	
R4, 10, 13	Carbon Film Resistor 1kΩ ±5% 1/2W	RD142HA102J	
R8	Carbon Film Resistor 1.5kΩ ±5% 1/2W	RD142HA152J	
R7	Carbon Film Resistor 2kΩ ±5% 1/2W	RD142HA202J	
R1, 2	Carbon Film Resistor 2.4kΩ ±5% 1/2W	RD142HA242J	
R9	Carbon Film Resistor 3kΩ ±5% 1/2W	RD142HA302J	
R11	Carbon Film Resistor 3.3kΩ ±5% 1/2W	RD142HA332J	
R15	Carbon Film Resistor 6.2kΩ ±5% 1/2W	RD142HA622J	
R16	Carbon Film Resistor 10kΩ ±5% 1/2W	RD142HA103J	
R5	Metal Film Resistor 2.2Ω ±5% 1W	RN143AA2R2J	
R6, 17	Metal Film Resistor 3.3Ω ±5% 1W	RN143AA3R3J	
C9	Electrolytic Capacitor 330μF 10WV	CE02W1A331	
C8	Electrolytic Capacitor 1000μF 10WV	CE02W1A102	
C5	Electrolytic Capacitor 1000μF 16WV	CE02W1C102	
C1, 2, 3, 4, 6, 7	Ceramic Capacitor 10000pF +80%, -20% 50WV	CK45F1H103Z	

AM FM FRONT-END (702-0002-00)
FM PRINTED CIRCUIT BOARD (709-0001-00)

*Printed circuit board as seen from the reverse side.

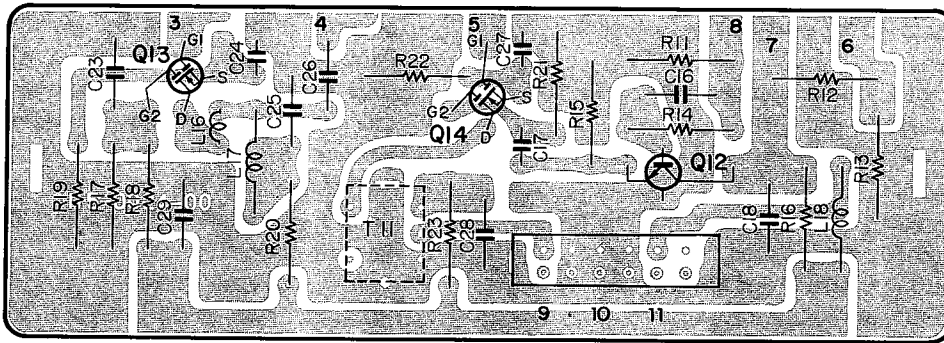

PARTS LIST

Ref. No.	Description	Part No.	Remarks
Q13	MOS FET	3SK41	
Q14	MOS FET	3SK35GR	
Q11, 12	Transistor	2SC785-R	
R19	Carbon Film Resistor 22Ω ±5% 1/2W	RD142HA220J	
R22	Carbon Film Resistor 220Ω ±5% 1/2W	RD142HA221J	
R20, 23	Carbon Film Resistor 470Ω ±5% 1/2W	RD142HA471J	
R16	Carbon Film Resistor 460Ω ±5% 1/2W	RD142HA561J	
R11, 15	Carbon Film Resistor 1kΩ ±5% 1/2W	RD142HA102J	
R17	Carbon Film Resistor 4.7kΩ ±5% 1/2W	RD142HA472J	
R14	Carbon Film Resistor 8.2kΩ ±5% 1/2W	RD142HA822J	
R13	Carbon Film Resistor 10kΩ ±5% 1/2W	RD142HA103J	
R12, 18	Carbon Film Resistor 12kΩ ±5% 1/2W	RD142HA123J	
R21	Carbon Film Resistor 100kΩ ±5% 1/2W	RD142HA104J	
C31	Minic Capacitor 0.68pF		
C30	Minic Capacitor 1pF		
C12, 16	Ceramic Capacitor 10pF ±0.5pF 50WV	CC45CH1H100D	Black (TC)
C14	Ceramic Capacitor 12pF ±5% 50WV	CC45CH1H120J	Black (TC)
C11	Ceramic Capacitor 12pF ±5% 50WV	CC45PH1H120J	Orange (TC)
C20, 21, 22	Ceramic Capacitor 15pF ±5% 50WV	CC45RH1H150J	Yellow (TC)
C17	Ceramic Capacitor 22pF ±5% 50WV	CC45CH1H220J	Black (TC)
C19	Ceramic Capacitor 22pF ±5% 50WV	CC45RH1H220J	Yellow (TC)
C13	Ceramic Capacitor 47pF ±5% 50WV	CC45CH1H470J	Black (TC)
C24, 26, 27	Ceramic Capacitor 0.01μF +80%, -20% 50WV	CK45F1H103Z	
C18, 23, 25, 28, 29	Ceramic Capacitor 0.022μF +80%, -20% 50WV	CK45F1H223Z	
T11	IFT	500-0001-00	
L16	ChokeCoil 0.18μH	506-0002-00	
L17	ChokeCoil 0.86μH	506-1001-00	
L18	ChokeCoil 1.0μH	506-1002-00	
	Printed Circuit Board Assembly	709-0001-00	with Parts

AM PRINTED CIRCUIT BOARD (709-1001-00)

*Printed circuit board as seen from the reverse side.

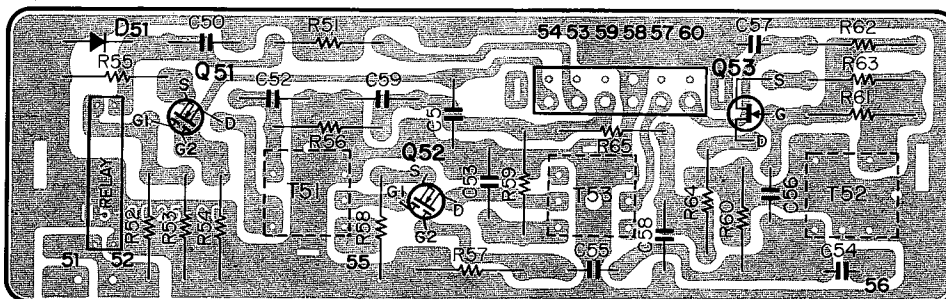

PARTS LIST

Ref. No.	Description	Part No.	Remarks
Q51, 52	MOS FET	3SK35-GR	
Q53	MOS FET	2SK30A-O	
D51	Silicon Diode	1S1555	
R55, 56, 58, 59	Carbon Film Resistor 220 Ω \pm 5% 1/2W	RD142HA221J	
R51	Carbon Film Resistor 820 Ω \pm 5% 1/2W	RD142HA821J	
R57	Carbon Film Resistor 22k Ω \pm 5% 1/2W	RD142HA223J	
R60	Carbon Film Resistor 56k Ω \pm 5% 1/2W	RD142HA563J	
R61	Carbon Film Resistor 100k Ω \pm 5% 1/2W	RD142HA104J	
R52	Carbon Film Resistor 330k Ω \pm 5% 1/2W	RD142HA334J	
R53, 54	Carbon Film Resistor 1M Ω \pm 5% 1/2W	RD142HA105J	
C55	Ceramic Capacitor 3pF \pm 0.25pF 50WV	CC45CH1H030C	Black (TC)
C57	Ceramic Capacitor 0.01 μ F +80%, -20% 50WV	CK45F1H103Z	
C50, 51, 52, 53, 58, 59	Ceramic Capacitor 0.047 μ F +80%, -20% 50WV	CK45F1H473Z	
C54	Mica Capacitor 390pF \pm 5% 100WV	CM93D2A391J	
C56	Mica Capacitor 690pF \pm 5% 100WV	CM93D2A681J	
TCA-3	Trimmer Capacitor 20pF	552-2001-00	OSC
T51	RF Coil	502-3001-00	
T52	OSC Coil	501-3001-00	
T53	IFT	500-3001-00	
L51	Choke Coil 1 μ H	506-1002-00	
	Reed Relay	363-1101-00	
	Connector Plug	304-0401-00	
	Connector Jack	304-5401-00	
	Connector Holder	248-0012-00	Connector Jack Stopper with Parts
	Printed Circuit Board Assembly	709-1001-00	

DELAY FUSE ASSEMBLY (716-0005-00)

PARTS LIST

Ref. No.	Description	Part No.	Remarks
F1, 2, 3	Fuse Holder	306-1001-00	
F4	Fuse 1A	310-0101-00	
	Fuse 3A	310-0301-00	
	Reed Relay	363-1201-00	
Q1, 2	Transistor NPN	2SC1416GR or BL	
D1, 2	Silicon Diode	1S1555	
R2	Carbon Film Resistor 47 Ω \pm 5% 1/2W	RD142HA470J	
R6	Carbon Film Resistor 150 Ω \pm 5% 1/2W	RD142HA151J	
R3	Carbon Film Resistor 1.2k Ω \pm 5% 1/2W	RD142HA122J	
R4, 5	Carbon Film Resistor 10k Ω \pm 5% 1/2W	RD142HA103J	
R1	Carbon Film Resistor 47k Ω \pm 5% 1/2W	RD142HA473J	
R8	Carbon Film Resistor 560 Ω \pm 5% 1/2W	RD142HA561J	
R7	Metal Film Resistor 1.0 Ω \pm 5% 1/2W	RN143AA1ROJX	
C2	Electrolytic Capacitor 220 μ F 16WV	CE02WIC221	
C1	Electrolytic Capacitor 220 μ F 6.3WV	CE02WOJ221	

FM IF and METER CIRCUIT ASSEMBLY (703-0001-00)

PRINTED CIRCUIT BOARD

*Printed circuit board as seen from the reverse side.

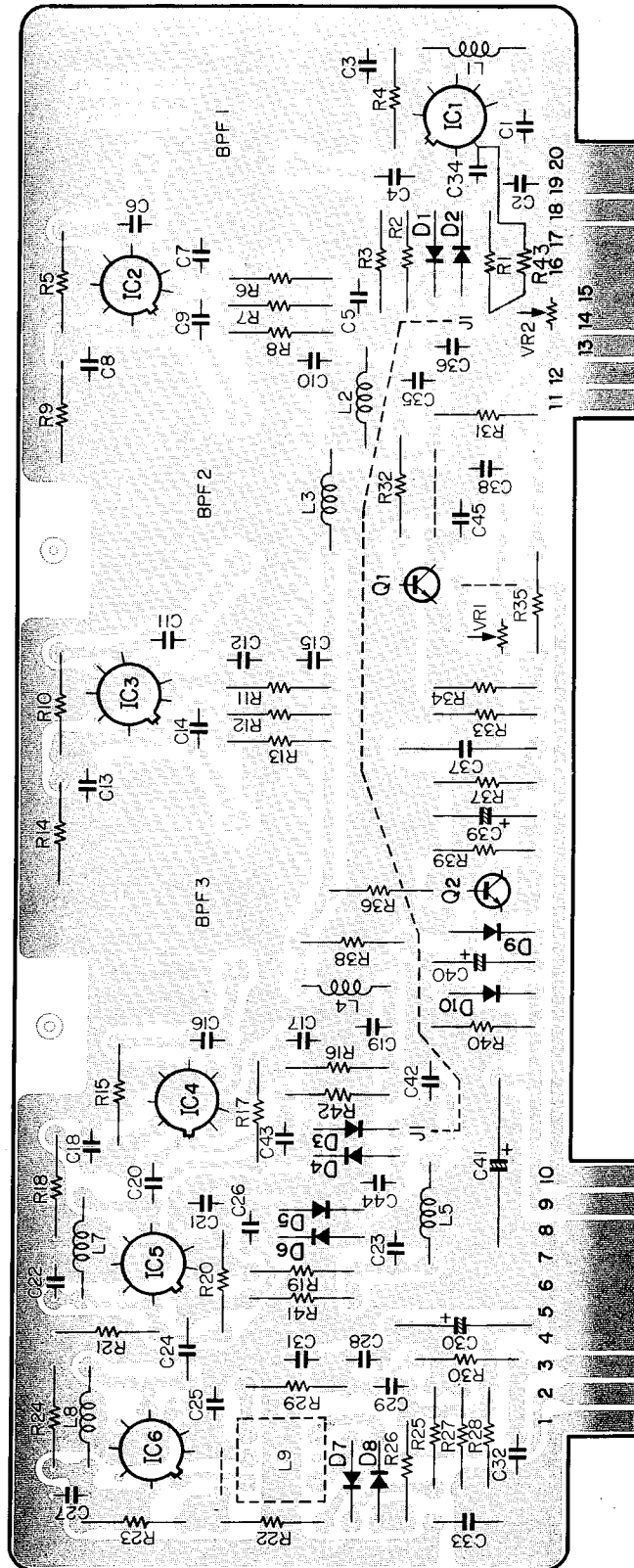

PARTS LIST

Ref. No.	Description	Part No.	Remarks
L9	FM Discr-Transformer	505-0001-00	
L2, 3, 4, 5	Choke Coil	506-1101-00	
L1, 7, 8	Choke Coil	506-1201-00	
BPF1, 2, 3	FM IF Band Pass Filter	520-0001-00	
VR2	Potentiometer 1k Ω	581-0132-00	for SIGNAL Meter adjust
VR1	Potentiometer 4.7k Ω	581-0531-00	for MUTING Level adjust
Q1, 2	Transistor NPN	2SC1416GR or BL	
IC1, 2, 3, 4, 5, 6	IC	TA7045M-R	
D2	Silicon Diode	1S555	
D1, 3, 4, 5, 6, 7, 8, 9, 10	Gelmanum Diode	1N60	
R1, 6, 11, 16, 19	Carbon Film Resistor 10 Ω \pm 5% 1/2W	RD142HA100J	
R31	Carbon Film Resistor 75 Ω \pm 5% 1/2W	RD142HA750J	
R29, 30	Carbon Film Resistor 100 Ω \pm 5% 1/2W	RD142HA101J	
R40	Carbon Film Resistor 220 Ω \pm 5% 1/2W	RD142HA221J	
R22	Carbon Film resistor 360 Ω \pm 5% 1/2W	RD142HA361J	
R5, 10, 15	Carbon Film Resistor 560 Ω \pm 5% 1/2W	RD142HA561J	
R2, 4, 7, 9, 12, 14, 18, 21, 24, 25, 26, 41, 42	Carbon Film Resistor 1k Ω \pm 5% 1/2W	RD142HA102J	
R3, 8, 13, 17, 20, 23, 39	Carbon Film Resistor 2k Ω \pm 5% 1/2W	RD142HA202J	
R27, 28	Carbon Film Resistor 3.3k Ω \pm 5% 1/2W	RD142HA332J	
R38	Carbon Film Resistor 4.7k Ω \pm 5% 1/2W	RD142HA472J	
R32	Carbon Film Resistor 10k Ω \pm 5% 1/2W	RD142HA103J	
R33, 34	Carbon Film Resistor 47k Ω \pm 5% 1/2W	RD142HA473J	
R35, 37	Carbon Film Resistor 56k Ω \pm 5% 1/2W	RD142HA563J	
R36	Carbon Film Resistor 100k Ω \pm 5% 1/2W	RD142HA104J	
R43	Carbon Film Resistor 390 Ω \pm 5% 1/2W	RD142HA391J	
C26	Ceramic Capacitor 2pF \pm 0.25pF 50WV	CC45SL1H020C	
C34	Ceramic Capacitor 10pF \pm 0.5pF 50WV	CC45SL1H100D	
C31, 36, 42	Ceramic Capacitor 100pF \pm 5% 50WV	CC45SL1H101J	
C28, 29, 35, 44	Ceramic Capacitor 220pF \pm 5% 50WV	CC45SL1H221J	
C32	Ceramic Capacitor 470pF \pm 10% 50WV	CK45B1H471K	
C1, 2, 3, 4, 5, 6, 7, 8, 9, 10, 11, 12, 13, 14, 15, 16, 17, 18, 19, 20, 21, 22, 23, 24, 25, 26, 27, 38, 45	Ceramic Capacitor 1000pF +80%, -20% 50WV	CK45F1H103Z	
C33	Ceramic Capacitor 4700pF +80%, -20% 50WV	CK45F1H473Z	
C43	Ceramic Capacitor 33pF \pm 5% 50WV	CC45SL1H330J	
C39, 40	Electrolytic Capacitor 1 μ F 50WV	CE02W1H010	
C30	Electrolytic Capacitor 10 μ F 16WV	CE02W1C100	
C41	Electrolytic Capacitor 100 μ F 10WV	CE02W1A101	
C37	Bipolar Electrolytic Capacitor 1 μ F 50WV	CE02W1H010 (BP)	

MPX and SUBCIRCUIT ASSEMBLY (706-0001-00)

PRINTED CIRCUIT BOARD

*Printed circuit board as seen from the reverse side.

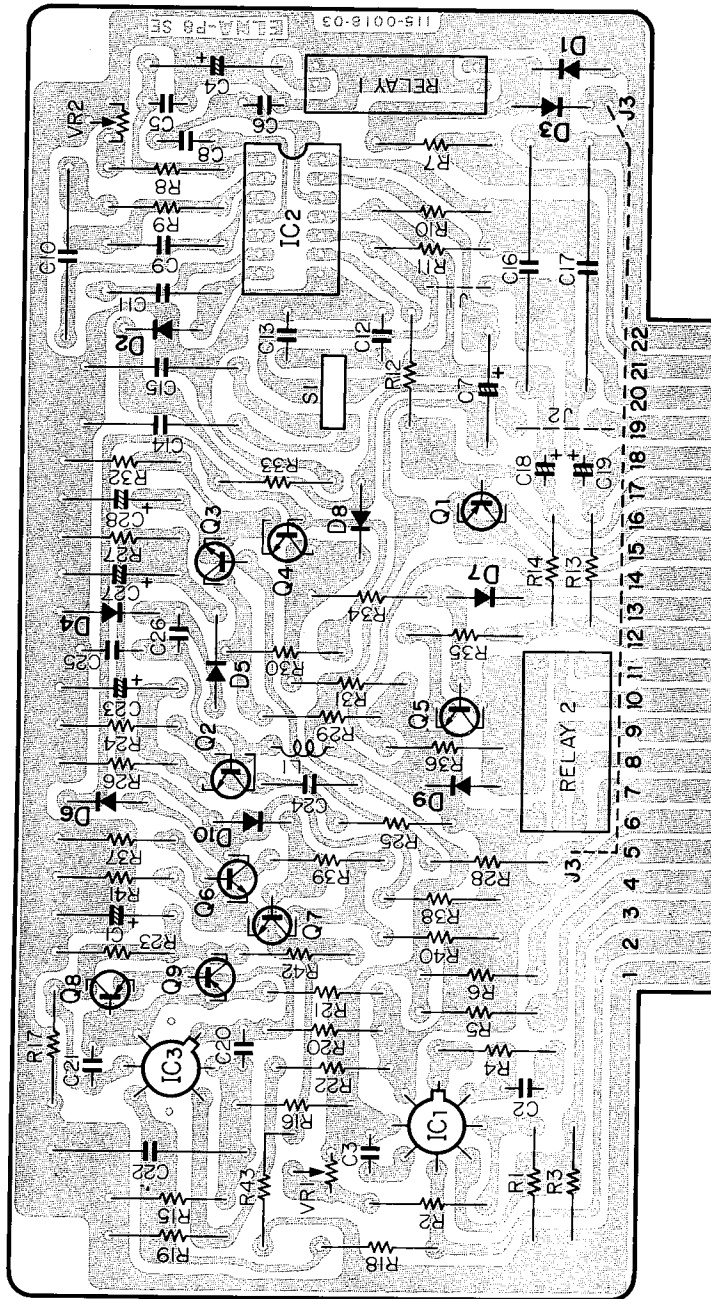

PARTS LIST

Ref. No.	Description	Part No.	Remarks
S1	IC Socket	300-1141-00	for MC1310P
RELAY1	Slide Switch	350-0201-00	for DEEMPHASIS
RELAY2	Reed Relay	363-1101-00	for MPX
L1	Reed Relay	363-1201-00	for MUTING
VR1	Choke Coil	506-1021-00	
VR2	Potentiometer	583-0141-00	for FM output adjust
	Potentiometer	583-0531-00	for 19kHz adjust

Ref. No.	Description	Part No.	Remarks
D4, 5, 7	Germanum Diode	1N60	
D1, 2, 6, 8, 9, 10	Silicon Diode	1S1555	
Q1	Transistor PNP	2SA497 O or Y	
Q8, 9	Transistor PNP	2SA776 GR or BL	
Q2, 3, 4, 5, 6, 7	Transistor NPN	2SC1416GR or BL	
IC2	IC	MC1310P	
IC1	IC	TA7502M	
IC3	IC	TA7045M R or BL	
R10, 11	Metal Film Resistor 7.5k Ω \pm 2% 1/2W	RN142HA7501GO	
R32	Carbon Film Resistor 82 Ω \pm 5% 1/2W	RD142HA820J	
R17	Carbon Film Resistor 4.2k Ω \pm 5% 1/2W	RD142HA432J	
R41	Carbon Film Resistor 220 Ω \pm 5% 1/2W	RD142HA221J	
R35	Carbon Film Resistor 390 Ω \pm 5% 1/2W	RD142HA391J	
R36	Carbon Film Resistor 470 Ω \pm 5% 1/2W	RD142HA471J	
R6	Carbon Film Resistor 620 Ω \pm 5% 1/2W	RD142HA621J	
R7	Carbon Film Resistor 820 Ω \pm 5% 1/2W	RD142HA821J	
R9	Carbon Film Resistor 1k Ω \pm 5% 1/2W	RD142HA102J	
R4	Carbon Film Resistor 1.5k Ω \pm 5% 1/2W	RD142HA152J	
R15	Carbon Film Resistor 2k Ω \pm 5% 1/2W	RD142HA202J	
R3, 12	Carbon Film Resistor 2.2k Ω \pm 5% 1/2W	RD142HA222J	
R1, 18	Carbon Film Resistor 2.7k Ω \pm 5% 1/2W	RD142HA272J	
R19, 20, 21	Carbon Film Resistor 3.3k Ω \pm 5% 1/2W	RD142HA332J	
R22	Carbon Film Resistor 3.9k Ω \pm 5% 1/2W	RD142HA392J	
R2	Carbon Film Resistor 4.7k Ω \pm 5% 1/2W	RD142HA472J	
R16, 43	Carbon Film Resistor 5.6k Ω \pm 5% 1/2W	RD142HA562J	
R23	Carbon Film Resistor 6.2k Ω \pm 5% 1/2W	RD142HA622J	
R26, 27, 28, 29, 31, 33, 34, 37, 38, 40, 42	Carbon Film Resistor 10k Ω \pm 5% 1/2W	RD142HA103J	
R30, 39	Carbon Film Resistor 27k Ω \pm 5% 1/2W	RD142HA273J	
R24, 25	Carbon Film Resistor 150k Ω \pm 5% 1/2W	RD142HA154J	
R13, 14	Carbon Film Resistor 1M Ω \pm 5% 1/2W	RD142HA105J	
R5	Carbon Film Resistor 22k Ω \pm 5% 1/2W	RD142HA223J	
R8	Carbon Film Resistor 16k Ω \pm 5% 1/2W	RD142HA163J	
C29	Ceramic Capacitor 0.01 μ F +80%, -20% 50WV	CK45F1H103Z	
C3	Ceramic Capacitor 22pF \pm 5% 50WV	CC45SL1H220J	
C24	Ceramic Capacitor 220pF \pm 5% 50WV	CC45SL1H221J	
C12, 13	Ceramic Capacitor 330pF \pm 5% 50WV	CC45SL1H331J	
C2	Ceramic Capacitor 680pF \pm 5% 50WV	CK45B1H681K	
C20, 21	Ceramic Capacitor 4700pF \pm 5% 50WV	CK45B1H472K	
C1	Electrolytic Capacitor 3.3 μ F 35WV	CE02W1V3R3	
C23, 27, 28	Electrolytic Capacitor 1.0 μ F 50WV	CE02W1H1R0	
C4	Electrolytic Capacitor 47 μ F 10WV	CE02W1A470	
C22	Bipolar Electrolytic Capacitor 1 μ F 50WV	CE02W1H1R0(BP)	
C14, 15	Polystyrene Film Capacitor 3900pF \pm 2% 125WV	CQ08S2B392G	
C16, 17	Polystyrene Film Capacitor 6800pF \pm 2% 125WV	CQ082SB682G	
C26	Mylar Film Capacitor 1000pF \pm 10% 50WV	CQ93M1H102K	
C8	Mylar Film Capacitor 0.047 μ F \pm 10% 50WV	CQ93M1H473K	
C9, 11	Mylar Film Capacitor 0.22 μ F \pm 5% 50WV	CQ93M1H224J	
C5	Mylar Film Capacitor 470pF \pm 5% 125WV	CQ93M2D471J	
C10	Metallized Film Capacitor 0.47 μ F \pm 20% 250WV	CQ93M2E474M	
C7	Tantalum Solid Capacitor 10 μ F +40%, -20% 25WV	CS02E1E100X	
C18, 19	Tantalum Solid Capacitor 1.0 μ F 25WV	CS15E1E010M	
C6	Mica Capacitor 470pF \pm 5% 100WV	CM93D2A471J	
C25	Mica Capacitor 1000pF \pm 5% 100WV	CM39D2A102J	

AM IF ASSEMBLY (704-0001-00)

PRINTED CIRCUIT BOARD

*Printed circuit board as seen from the reverse side.

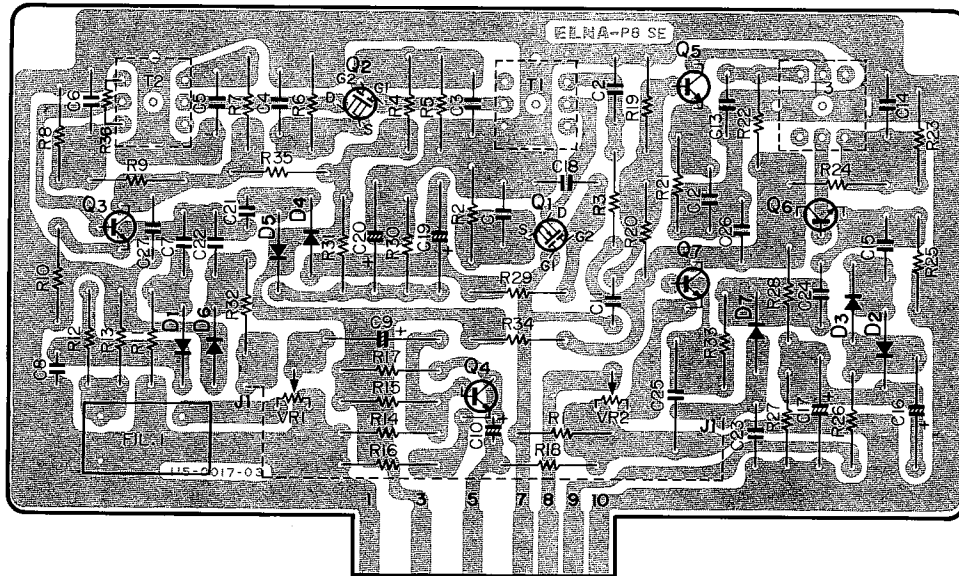

PARTS LIST

Ref. No.	Description	Part No.	Remarks
T1, 2, 3	AM IFT	500-3001-00	
FIL1	10kHz Trap Block	520-8001-00	
VR2	Potentiometer 4.7k Ω	581-0531-00	for adjust SIGNAL meter
VR1	Potentiometer 100k Ω	581-0151-00	for adjust AM output
Q3, 4, 5, 6, 7	Transistor NPN	2SC1416BL	
Q1, 2	MOS FET	3SK35GR or BL	
D1, 2, 3, 4, 5, 6, 7	Germanium Diode	1N60	
R34	Carbon Film Resistor 10 Ω \pm 5% 1/2W	RD142HA100J	
R2, 3, 6, 7, 22, 35	Carbon Film Resistor 220 Ω \pm 5% 1/2W	RD142HA221J	
R21	Carbon Film Resistor 1k Ω \pm 5% 1/2W	RD142HA102J	
R16	Carbon Film Resistor 1.8k Ω \pm 5% 1/2W	RD142HA182J	
R27	Carbon Film Resistor 2.2k Ω \pm 5% 1/2W	RD142HA222J	
R30	Carbon Film Resistor 3.3k Ω \pm 5% 1/2W	RD142HA332J	
R5, 17	Carbon Film Resistor 3.9k Ω \pm 5% 1/2W	RD142HA392J	
R9, 24	Carbon Film Resistor 5.1k Ω \pm 5% 1/2W	RD142HA512J	
R10, 25	Carbon Film Resistor 6.8k Ω \pm 5% 1/2W	RD142HA682J	
R8, 11, 23, 31	Carbon Film Resistor 10k Ω \pm 5% 1/2W	RD142HA103J	
R4	Carbon Film Resistor 12k Ω \pm 5% 1/2W	RD142HA123J	
R13	Carbon Film Resistor 13k Ω \pm 5% 1/2W	RD142HA133J	
R28	Carbon Film Resistor 16k Ω \pm 5% 1/2W	RD142HA163J	
R12, 19	Carbon Film Resistor 47k Ω \pm 5% 1/2W	RD142HA473J	
R26, 29, 36	Carbon Film Resistor 100k Ω \pm 5% 1/2W	RD142HA104J	
R14, 20	Carbon Film Resistor 220k Ω \pm 5% 1/2W	RD142HA224J	
R15	Carbon Film Resistor 470k Ω \pm 5% 1/2W	RD142HA474J	
R1, 32, 33, 18	Carbon Film Resistor 1M Ω \pm 5% 1/2W	RD142HA105J	
R21, 22	Carbon Film Resistor 390k Ω \pm 5% 1/2W	RD142HA394J	
R31, 32	Carbon Film Resistor 910k Ω \pm 5% 1/2W	RD142HA914J	
C11	Ceramic Capacitor 47pF \pm 10% 50WV	CC45SLH470K	
C8, 21	Ceramic Capacitor 330pF \pm 5% 50WV	CC45SLH331J	
C1, 2, 3, 4, 5, 6, 7, 12, 13, 14, 15, 18, 22, 23, 24, 26, 27	Ceramic Capacitor 0.047 μ F +80%, -20% 50WV	CK45F1H473Z	
C9, 19	Electrolytic Capacitor 1 μ F 50WV	CE02W1H01C	
C17, 20	Electrolytic Capacitor 4.7 μ F 35WV	CE02W1V4R7	
C16	Electrolytic Capacitor 3.3 μ F 35WV	CE02W1V3R3	
C25	Mylar Film Capacitor 0.22 μ F \pm 5% 50WV	CQ93M1H224J	

AUDIO AMP. ASSEMBLY (714-0003-00)

PRINTED CIRCUIT BOARD

*Printed circuit board as seen from the reverse side.

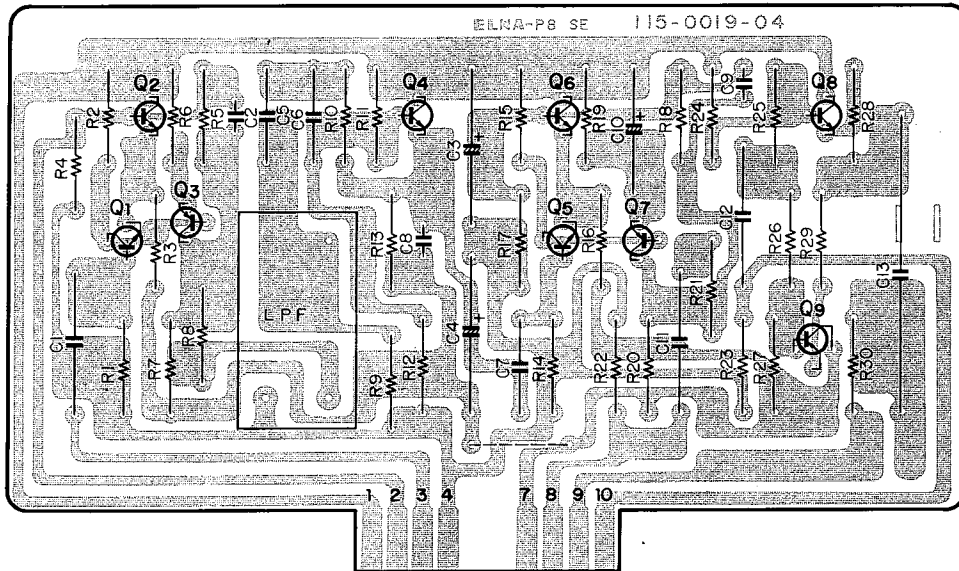

PARTS LIST

Ref. No.	Description	Part No.	Remarks
	Low Pass Filter	520-5001-00	
Q3, 7, 9	Transistor PNP	2SA776 Y or GR	
Q1, 2, 4, 5, 6, 8	Transistor NPN	2SC1416A GR or BL	
R30	Carbon Film Resistor 47 ±5% 1/2W	RD142HA470J	
R28, 29	Carbon Film Resistor 100 ±5% 1/2W	RD142HA101J	
R6, 19, 21	Carbon Film Resistor 220 ±5% 1/2W	RD142HA221J	
R8	Carbon Film Resistor 2.2k ±5% 1/2W	RD142HA222J	
R7, 20	Carbon Film Resistor 2.7k ±5% 1/2W	RD142HA272J	
R9, 13	Carbon Film Resistor 3.3k ±5% 1/2W	RD142HA332J	
R23	Carbon Film Resistor 10k ±5% 1/2W	RD142HA103J	
R25, 26	Carbon Film Resistor 16k ±5% 1/2W	RD142HA163J	
R10	Carbon Film Resistor 22k ±5% 1/2W	RD142HA223J	
R2, 15	Carbon Film Resistor 33k ±5% 1/2W	RD142HA333J	
R4, 17	Carbon Film Resistor 36k ±5% 1/2W	RD142HA363J	
R14	Carbon Film Resistor 56k ±5% 1/2W	RD142HA563J	
R5, 18, 22	Carbon Film Resistor 100k ±5% 1/2W	RD142HA104J	
R24, 27	Carbon Film Resistor 330k ±5% 1/2W	RD142HA334J	
R3, 16	Carbon Film Resistor 82k ±5% 1/2W	RD142HA823J	
R1	Carbon Film Resistor 110k ±5% 1/2W	RD142HA114J	
R12	Carbon Film Resistor 160k ±5% 1/2W	RD142HA164J	
R11	Carbon Film Resistor 270k ±5% 1/2W	RD142HA274J	
C2, 9	Ceramic capacitor 2pF ±0.25pF 50WV	CC45SL1H020C	
C10	Electrolytic capacitor 220µF 10WV	CE02W1A221	
C3, 4	Electrolytic capacitor 100µF 25WV	CE02W1E101	
C11	Bipolar Electrolytic Capacitor 4.7µF 50WV	CE02W1H4R7(BP)	
C8	Mica Capacitor 470pF ±5% 100WV	CM93D2A471J	
C5, 6, 7	Mylar Film Capacitor 0.22µF ±5% 50WV	CQ93M1H224J	
C13	Metallized Film Capacitor 4.7µF 250WV	CQ91M2E475(M)	
C1, 12	Metallized Film Capacitor 0.47µF 250WV	CQ91M2E474(M)	

CIRCUIT DESCRIPTION

T-100 ALIGNMENT INSTRUCTIONS

All ACCUPHASE tuners are carefully aligned and tested at the factory using the finest available test equipment.

All ACCUPHASE tuners will meet their published specifications when shipped from the factory.

After extensive operation, or servicing, it may be desirable to realign the tuner circuits for best performance. The alignment charts give complete information on the circuit realignment procedure for the T-100.

The test equipment listed (or it's equivalent) is necessary to properly align a T-100. The accuracy of the alignment will be directly related to the accuracy and calibration of the test equipment used.

If the necessary test equipment is not available, alignment should not be attempted. For additional information contact Technical Service Department of our ACCUPHASE Distributor.

TEST EQUIPMENT REQUIRED

1. FM Signal Generator (Measurements 188 or equivalent)
2. AM Signal Generator (Measurement 65B or equivalent)
3. VTVM
4. Multiplex Generator (Radio meter SMG 1, or equivalent)
5. 10.7MHz Generator (Preferably crystal controlled)
6. Oscilloscope (Commercial Grade or equivalent)
7. Harmonic Distortion Analyzer (Hewlett-Packard 333A or equivalent)

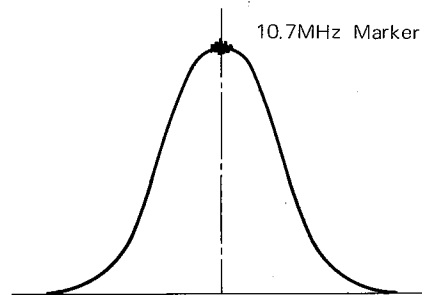

Fig. 1 FM IF CURVE

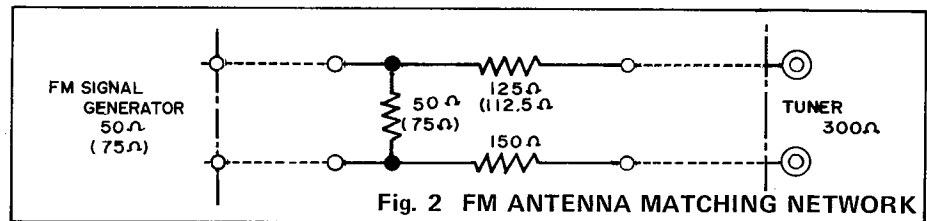

Fig. 2 FM ANTENNA MATCHING NETWORK

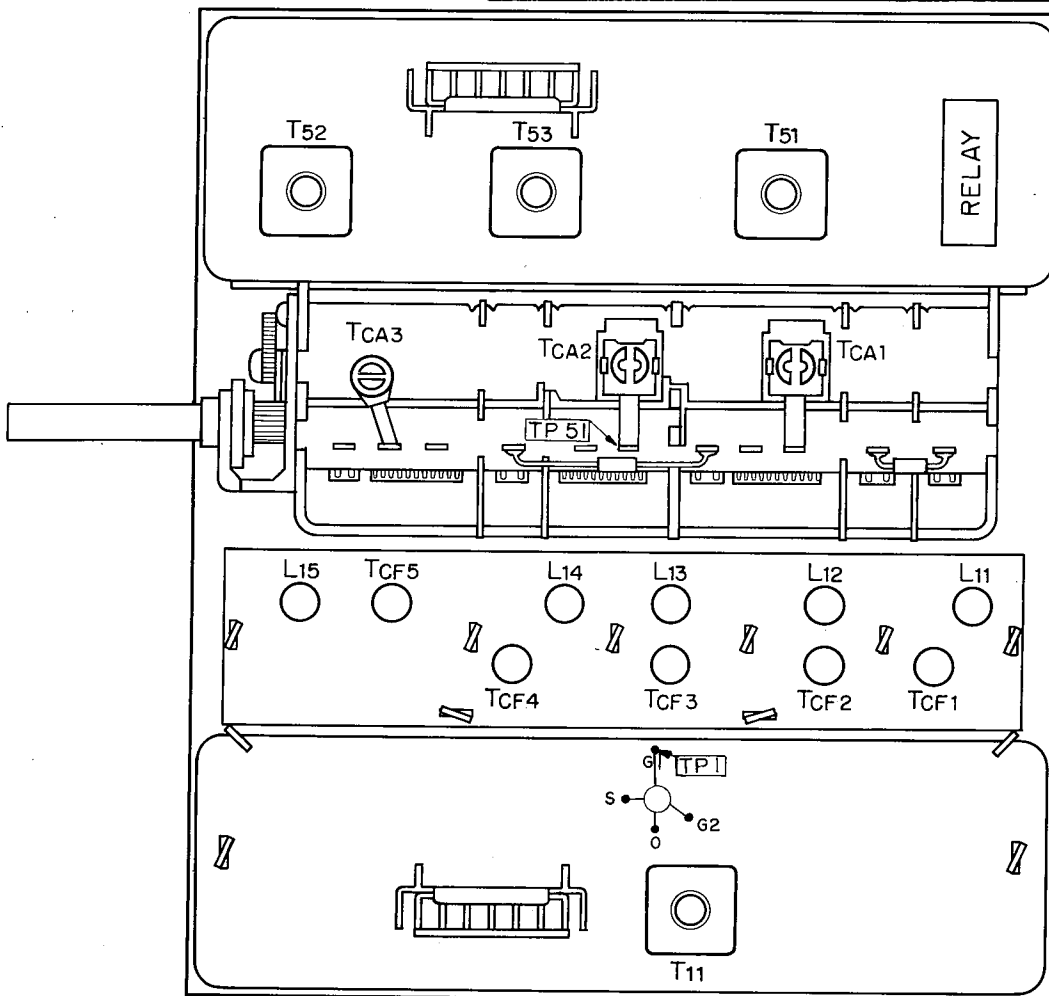

Fig. 3 ADJUST POINT ON AM FM FRONT-END ASSEMBLY

FM/MULTIPLEX ALIGNMENT

STEP	ADJUST ITEM	TUNER DIAL SETTING	SIGNAL GENERATOR				INDICATOR		ADJUST	TEST LIMITS	REMARKS
			TYPE	FREQ.	COUPLING	MODULATION	TYPE	CONNECTED TO			
1	IF	Point of no interference	SWEEP Generator	10.7MHz	Through external 1PF capacitor to TP-1 (Q14G1) on Front end assembly (702-0001-00)	LINE Sweep	Oscilloscope	TP2 on IF assembly (703-0001-00)	Top (secondary) and bottom (primary) of TP1 on Front end assembly (702-0002-01)	Maximum height of 10.7MHz marker and best symmetry curve as Fig. 1	Keep sweep generator output as low as possible to prevent IF waveform from over shooting the scope screen.
2	DETECTOR	Same	Received FM noise				TUNING METER		Top (secondary) of L9 on IF assembly (703-0001-00)	Midpoint indication of TUNING METER	Keep TUNER in MONO mode with MUTING at OFF for step 2 through step 9.
3	SIGNAL METER	106MHz	FM signal Generator	106MHz OUTPUT 96dB	Through antenna matching network to 300Ω ANT terminals	CW	SIGNAL METER		VR2 on IF assembly (703-0001-00)	"5" Point indication of SIGNAL METER	About 1/3 clockwise turn should produce a METER reading of "5". If unattainable repeat this step after completing step 9.
4	DETECTOR	Same	Same	106MHz	Same	400Hz ± 75KHz deviation	Oscilloscope VTVM Distortion meter	FIXED AUDIO OUTPUT	Bottom (primary) of L9 on IF assembly (703-0001-00)	Maximum audio output and minimum distortion	Adjust FM signal generator output to obtain reading of "2.5" on the SIGNAL METER at perfect resonance, indicated by the maximum deflection of the SIGNAL METER and midpoint indication of the TUNING METER. Distortion will be less than 0.2% if a high quality FM signal generator is used.
5	AUDIO OUTPUT	Same	Same	106MHz OUTPUT 66dB	Same	Same	Same	Same	VR1 on MPX assembly (700-0001-00)	2.0V audio output	Same
6	CALIBRATION	Same	Same	106MHz	Same	Same	Same	Same	Oscillator trimmer Tce 5 on Front end assembly (704-0001-00)	Maximum SIGNAL METER. Midpoint TUNING METER	Keep FM signal generator output level the same as in step 4.
7	Same	Same	Same	90MHz	Same	Same	Same	Same	Oscillator coil L15 on Front-end assembly (704-0001-00)	Same	Keep repeating step 6 and 7 back and forth, until dial accurately indicates 90MHz and 106MHz during resonance with FM signal generator. Also check accuracy of other frequency reading.
8	TRACKING	106MHz	Same	106MHz OUTPUT 12dB	Same	Same	Same	Same	Tce 1, 2, 3, 4 on Front-end assembly (704-0001-00)	Adjust for minimum noise and distortion	S/N will be more than 40dB. Distortion less than 3%.
9	Same	90MHz	Same	90MHz OUTPUT 12dB	Same	Same	Same	Same	L11, 12, 13, 14 on Front-end assembly (704-0001-00)	Same	Same as above. Repeat step 8 and Check again.
10	MUTING LEVEL	Same	Same	90MHz OUTPUT 32 ~ 38dB	Same	400Hz ± 22.5KHz deviation	Same	Same	VR1, on IF assembly (703-0001-00)	ON/OFF audio output	Set MUTING switch to "2", and VR1 to maximum clockwise position. Then back off VR1 slowly in counterclockwise direction until audio output is obtained. Next set MUTING switch to "1". Reduce FM signal generator output by about 20dB around which point audio output ON/OFF should now occur. Check this.
<p>NOTE: Since the ANT and RF circuits are double tuned, an RF sweep generator is necessary for realignment. Avoid touching parts in the cavity except for replacing parts thereof. If not audio output is obtained during step 4, see if it becomes available when an oscilloscope is connected to the DETECTOR OUTPUT. If so, it will be an indication of some trouble within the MPX assembly. The DE-EMPHASIS switch S1 within the MPX assembly (706-0001-00) should be set to 50μS or 75μS whichever conforms with the practice in the country in which this tuner is used.</p>											
11	MULTIPLEX	100MHz	MULTIPLEX Generator FM signal Generator	100MHz OUTPUT 66dB	Same	400Hz, L-R	Same	Same	VR2 on MPX assembly (706-0001-00)	Maximum audio output and minimum distortion	Tune for perfect resonance.
12	SEPARATION	Same	Same	Same	Same	400Hz, L-R	Same	Same	VR3 on the chassis	Adjust for Maximum separation	Inverse signal and check both channels.

STEP	ADJUST ITEM	TUNER DIAL SETTING	SIGNAL GENERATOR				INDICATOR		ADJUST	TEST LIMITS	REMARKS
			TYPE	FREQ.	COUPLING	MODULATION	TYPE	CONNECTED TO			
1	I F	Point of no interference	SWEEP Generator	455KHz	TP51 on Front-end assembly (702-0001-01)	LINE Sweep	Oscilloscope	TP53 on IF assembly (704-0001-00)	Maximum height of 455KHz marker and best symmetry curve as Fig. 4.	Keep sweep generator output as low as possible to prevent IF waveform from over-running scope screen. Push in AM DIST button. Set AM LEVEL to MAX.	
2	AGC	1,000KHz	AM signal Generator	1,000KHz OUTPUT 80dB	Through external 250Ω resistor to ANT terminals.	CW	MULTI-TESTER	Top and Bottom of T3 on IF assembly (704-0001-00)	Adjust for maximum (-) DC voltage	Should be at least DC-0.5V	
3	CALIBRATION	1,400KHz	Same	1,400KHz	Same	30%	Oscilloscope V/I/V/M Distortion meter	Oscillator trimmer Tca 3 on Front-end assembly (702-0001-01)	Maximum audio output	Set AM loop stick antenna in horizontal position. Keep signal generator output as low as possible.	
4	Same	600KHz	Same	600KHz	Same	Same	Same	Oscillator coil T52 on Front-end assembly (702-0002-01)	Same	Same as above. Repeat step 3 and 4, back and forth, until dial pointer indicates correct resonant frequencies.	
5	TRACKING	1,400KHz	Same	1,400KHz	Same	Same	Same	Tca 1, 2, on Front-end assembly (702-0002-01)	Same	Set signal generator output to less than 30dB.	
6	Same	600KHz	Same	600KHz	Same	Same	Same	T51 on Front-end assembly (702-0002-01) and AM LOOP STICK antenna.	Same	Same as above. Repeat step 5 and 6 until perfect tracking is obtained. This unit is rated at S/N 20dB against a 24dB input signal in a shielded room, provided 25 ~ 28dB input outside shielded room.	
7	AUDIO OUTPUT	600KHz	Same	600KHz OUTPUT 60dB	Same	Same	Same	VR1 on IF assembly (704-0001-00)	0.6V audio output	Check distortion. It should be less than 0.5% if a highquality signal generator is used.	
8	SIGNAL METER	600KHz	Same	600KHz OUTPUT 90dB	Same	CW	SIGNAL METER	VR2 on IF assembly (704-0001-01)	"5" point indication of SIGNAL METER		

NOTE: Sensitivity will drop about 20dB if the AM LOCAL button is depressed in place of the DIST button.

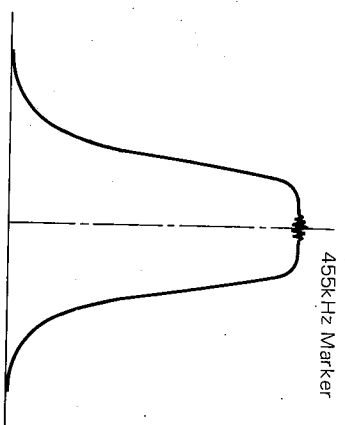
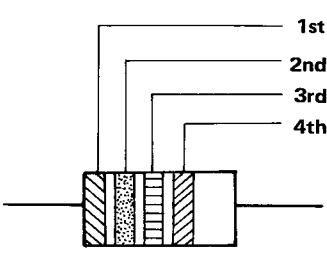

Fig. 4 AM IF CURVE

RESISTOR COLOR CODE

4 COLOR CODE RESISTOR

COLOR (Meaning)	1st (Value)	2nd (Value)	3rd (Multiplier)	4th (Tolerance)	Remarks
Black	0	0	10^0	± 1%	
Brown	1	1	10^1		
Red	2	2	10^2	± 2%	
Orange	3	3	10^3		
Yellow	4	4	10^4	10^5	
Green	5	5	10^5		
Blue	6	6	10^6	10^7	
Purple	7	7	10^7		
Grey	8	8	10^8	10^{-1}	
White	9	9	10^9		
Gold	—	—	10^{-1}	± 5%	
Silver	—	—	10^{-2}	±10%	
Non-Color	—	—	—	±20%	

5 COLOR CODE RESISTOR

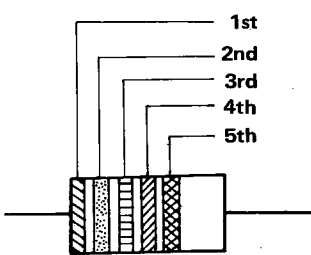
COLOR (Meaning)	1st (Value)	2nd (Value)	3rd (Value)	4th (Multiplier)	5th (Tolerance)	Remarks
Black	0	0	0	10^0	± 1%	
Brown	1	1	1	10^1		
Red	2	2	2	10^2	± 2%	
Orange	3	3	3	10^3		
Yellow	4	4	4	10^4	10^5	
Green	5	5	5	10^5		
Blue	6	6	6	10^6	10^7	
Purple	7	7	7	10^7		
Grey	8	8	8	10^8	10^{-1}	
White	9	9	9	10^9		
Gold	—	—	—	10^{-1}	± 5%	
Silver	—	—	—	10^{-2}	±10%	
Non-Color	—	—	—	—	±20%	

EXAMPLE

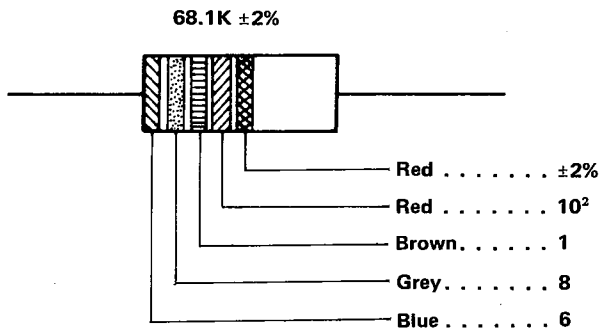

SEMI-CONDUCTOR LEADS

AM FM FRONT-END ASSEMBLY

REF. NO.	DESCRIPTION	PICTURE 1
Q11, Q12	2SC785 - R	B
Q13	2SK41	A
Q14, Q51, Q52	3SK35 - GR	A
Q53	2SK30A - O	J

FM IF and METER ASSEMBLY

REF. NO.	DESCRIPTION	PICTURE 1
Q1, Q2	2SC1416 GR or BL	F
IC1, IC2, IC6, IC2, IC4, IC5	TA7045 M-R TA7045 M-BL	H

MPX and SUBCIRCUIT ASSEMBLY

REF. NO.	DESCRIPTION	PICTURE 1
Q1	2SA497 O or Y	G
Q8, Q9	2SA776 GR or BL	F
Q2, Q3, Q4, Q5, Q6, Q7	2SC1416 GR or BL	F
IC1	TA7052M	H
IC3	TA7045M MR or BL	H
IC2	MC1310P	I

AM IF ASSEMBLY

REF. NO.	DESCRIPTION	PICTURE 1
Q3, Q4, Q5, Q6, Q7	2SC1416 - BL	F
Q1, Q2	3SK35 GR or BL	A

AUDIO AMP. ASSEMBLY

REF. NO.	DESCRIPTION	PICTURE 1
Q3, Q7, Q9	2SA776 GR or BL	F
Q1, Q2, Q4, Q5, Q6, Q8	2SC1416A GR or BL	F

POWER SUPPLY ASSEMBLY

REF. NO.	DESCRIPTION	PICTURE 1
Q1, Q5	2SA661 OY or GR	C
Q4	2SB435 O or Y	D
Q2, Q6	2SC1166 OY or GR	C
Q3, Q7	2SD235 O or Y	D

DELAY FUSE ASSEMBLY

REF. NO.	DESCRIPTION	PICTURE 1
Q1, Q2	2SC1416 GR or BL	F

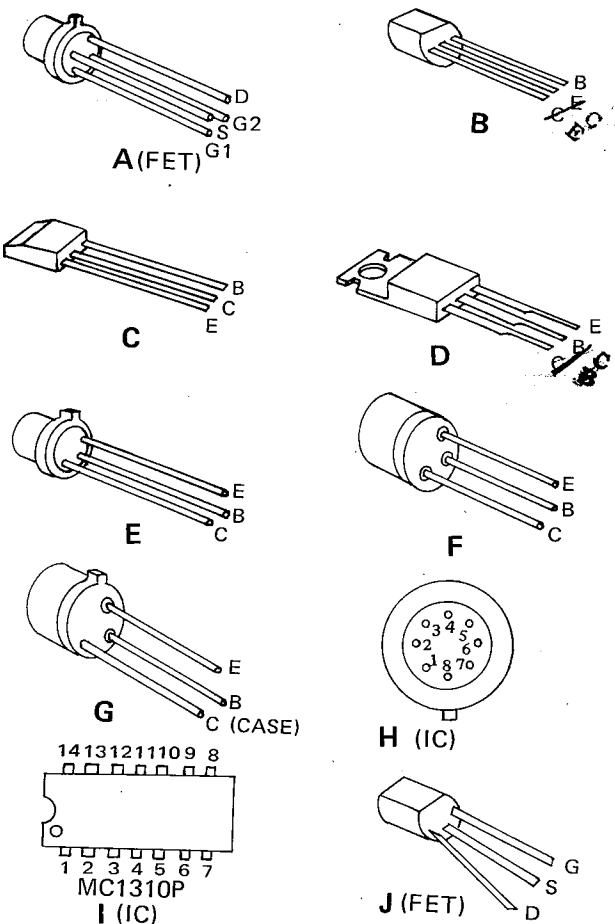

PICTURE 1

Use of transistors other than specified will adversely affect performance and should be avoided.

THE MARK OF CAPACITOR AND RESISTORS ON THE SCHEMATIC DIAGRAM

- | | |
|--------------------------------|--|
| ○: CERAMIC CAPACITORS | □: METAL FILM RESISTORS |
| ⊖: MICA CAPACITORS | ■: OXED METAL FILM RESISTORS |
| ⊗: TANTALUM SOLID CAPACITORS | ⊠: CEMENT COATED WIRE WOUND RESISTORS |
| ●: METALLIZED FILM CAPACITOR | ⊡: CEMENT COATED METAL PLATE RESISTORS |
| ⊕: POLYSTYRENE FILM CAPACITORS | |
| ⊙: MYLAR FILM CAPACITORS | |

Unless other wise specified: Capacitors are ELECTROLYTIC Types: Resistors are CARBON FILM Types, 1/2 watt, and ±5% tolerance;

Indicated values of parts in the schematic diagram may be changed in case of performance improvement.

SCHEMATIC DIAGRAM

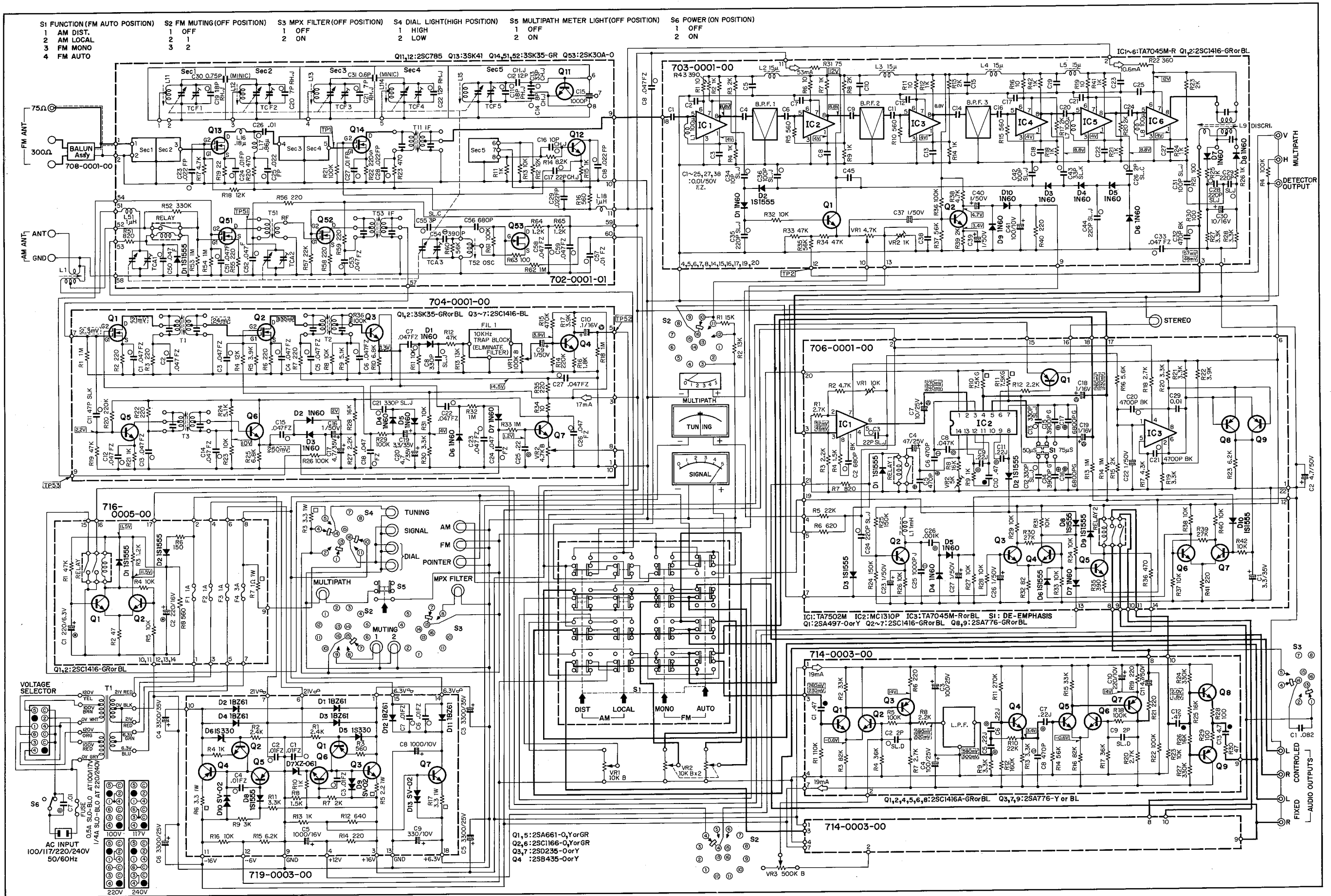

SPECIFICATIONS

- PERFORMANCE GUARANTY:** Products of Kensoic guarantee specifications stated.
- **FM MONOPHONIC Performance:**
 - SENSITIVITY:** 2.0 μ V IHF
2.0 μ V for 40 dB of quieting.
4.5 μ V for 50 dB of quieting.
 - ULTIMATE S/N:** 75 dB at 200 μ V input.
 - ULTIMATE THD:** at 50 μ V input, 100% modulation.
 - 100Hz: will not exceed 0.1 %
 - 1,000Hz: will not exceed 0.1 %
 - 10,000Hz: will not exceed 0.1 %
 - INTERMODULATION DISTORTION:** will not exceed 0.2 % (Antenna input 1 mV, 100 % Mod , 70 Hz : 7 kHz = 4:1)
 - AUDIO FREQUENCY RESPONSE:** +0, -1 dB 20 Hz to 15,000Hz
 - SELECTIVITY:** Alternate channel: 70 dB
 - CAPTURE RATIO:** 1.5 dB
 - IMAGE REJECTION:** 90 dB at 100MHz
 - IF REJECTION:** 100 dB
 - SPURIOUS REJECTION:** 100 dB
 - AM REJECTION:** 60 dB at 1 mV input
 - OUTPUT:** 2.0 Volts
 - **FM Stereo Performance:**
 - SENSITIVITY:** 20 μ V for 40 dB of quieting.
45 μ V for 50 dB of quieting.
 - ULTIMATE S/N:** 70 dB at 2 mV input.
 - ULTIMATE THD:** at 500 μ V input, 100% modulation.
 - 100 Hz: will not exceed 0.2 %
 - 1,000 Hz: will not exceed 0.2 %
 - 10,000 Hz: will not exceed 0.5 %
 - AUDIO FREQUENCY RESPONSE:** +0, -1 dB 20 Hz to 15,000Hz
 - STEREO SEPARATION:** 35 dB at 100 Hz
45 dB at 1,000 Hz
30 dB at 10 kHz
 - STEREO AND MUTING THRESHOLD:** Two-step switching at 5 μ V and 20 μ V.
 - SCA REJECTION:** 60 dB
 - 19 kHz, 38 kHz REJECTION:** 70 dB
 - **AM Performance:**
 - SENSITIVITY:** 15 μ V DISTANCE 150 μ V LOCAL
 - S/N:** 50 dB (Antenna input 1 mV, 30 % Mod. at 1 kHz)
 - THD:** will not exceed 0.5 % (Antenna input 1 mV, 30 % Mod. at 1 kHz)
 - SELECTIVITY:** 30 dB
 - IMAGE REJECTION:** 70 dB
 - IF REJECTION:** 60 dB
 - WHISTLE FILTER:** -30 dB at 10 kHz
 - OUTPUT:** 0.6 Volts (30 % Mod.)
 - **General**
 - AM BAND** 535 ~ 1605kHz
 - FM BAND** 88 ~ 108 MHz
 - TUNING CAPACITOR:** FM: Frequency Linear 5-gang AM: 3-gang
 - OUTPUT IMPEDANCE:** Audio Output FIXED: 200 ohms
Audio Output CONTROLLED: 2.5 k ohms
300 ohms balanced; 75 ohms unbalanced.
 - FM ANTENNA INPUTS:** Signal Strength Meter Center Tuning Meter Multipath Meter
 - METERS:**
 - POWER REQUIREMENT:** Voltage selector for 100 V, 117 V, 220 V, 240 V 50/60 Hz operation.
Consumption: 26 watts
 - SEMICONDUCTOR COMPLEMENT:** 7 FETs, 45 Transistors, 9 ICs, 43 Diodes
 - DIMENSIONS:** 455mm (17½ inches) wide, 152mm (6 inches) high, 355mm (14 inches) deep
 - WEIGHT:** 14kgr. (30.8 pounds) net, 18.3kgr. (40.6 pounds) in shipping carton.



KENSONIC LABORATORY INC.
2124-6 MOTOISHOKAWA-CHO,
MIDORIKU, YOKOHAMA, JAPAN